



C50 PRO

USER MANUAL



This user manual covers everything you need to know about your C50 PRO

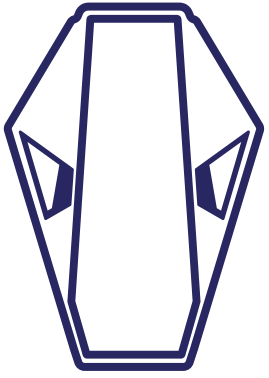

**About C50**

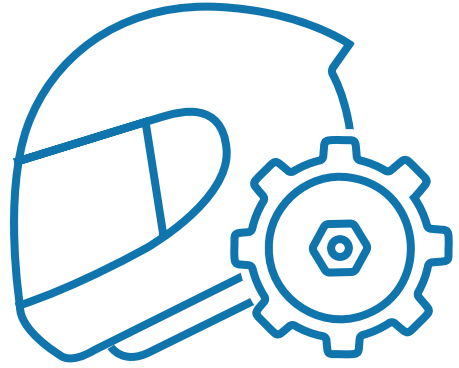

**Installation Steps**

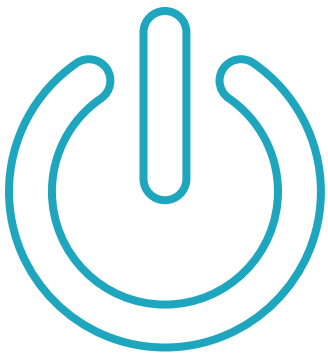

**Getting Started**



**Phone Usage**



**RideAura**

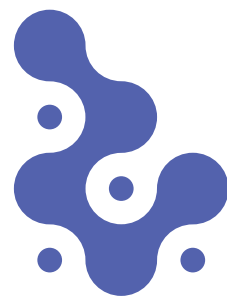

**RIDEGRID 2.0™**

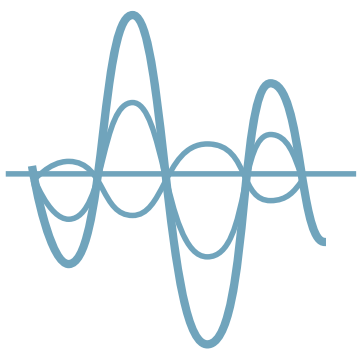

**Audio/Voice Experience**



**PORTWEAVE™**

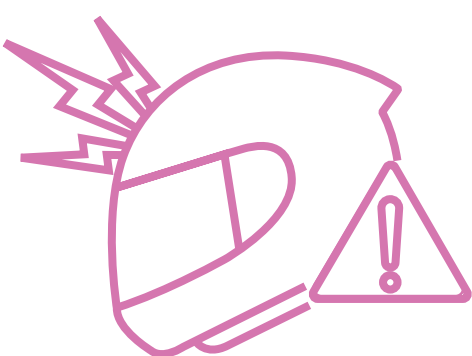

**Crash Detection**

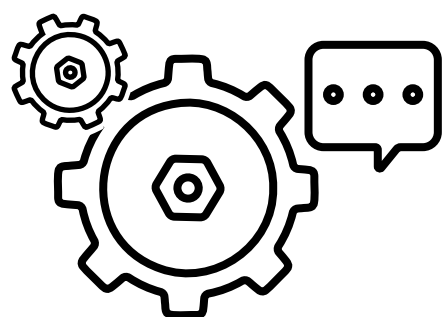

**Settings & FAQ's**

# About C50

**Congratulations**  
on purchasing your C50 PRO



- 01** - OVERVIEW
- 02** - WHAT'S IN THE BOX
- 03** - C50 & THE TSTICK



## 01 OVERVIEW

# C50 PRO

At BluArmor, innovation and value are at the heart of everything we do, and the all-new C50 Pro exemplifies our commitment to pushing boundaries across all segments. This next-generation helmet communication system redefines excellence, showcasing BluArmor's latest technologies in a sleek, world-class package. Building on the proven success of the C30, the C50Pro seamlessly combines customer needs and desires, addressing every challenge of its predecessor—from design and form factor to usability—while setting a new benchmark in performance and style. The C50Pro is more than just an upgrade; it's a bold leap forward, making it our true flagship product.



# 02 WHAT'S IN THE BOX

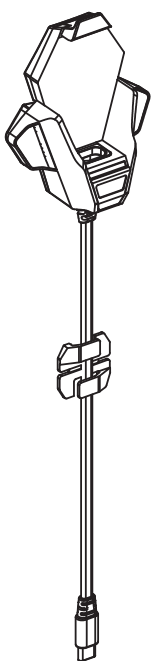
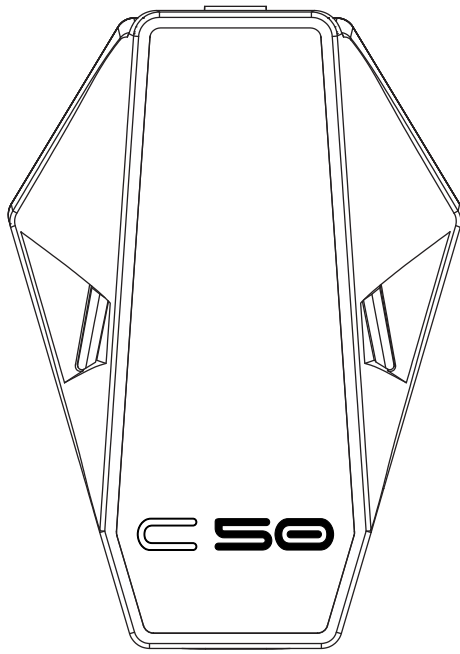

MagDock with Cable Manager

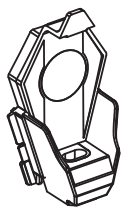

Wing Mount Compatible ClickDock



Charging Cable

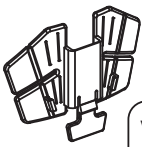

Wing Mount

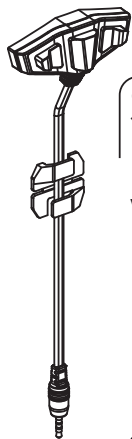

3 Button Module with Cable Manager



Magnetic Charging Adapter

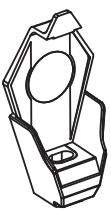

Spare ClickDock



Rear Flap



Button Mic



Boom Mic

Wire Harness



MagDock VHB

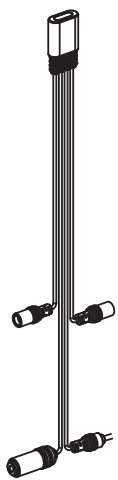

ClickDock Cable

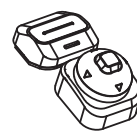

TStick

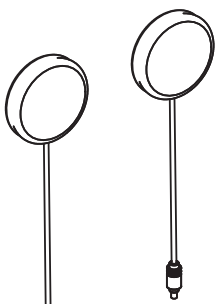

Tuned by BLU Speakers

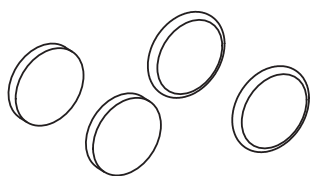

Speaker Spacers and Foams



TStick Strap Mount



TStick Velcro Mount



03

## C50 AND THE TSTICK

### C50 UNIT

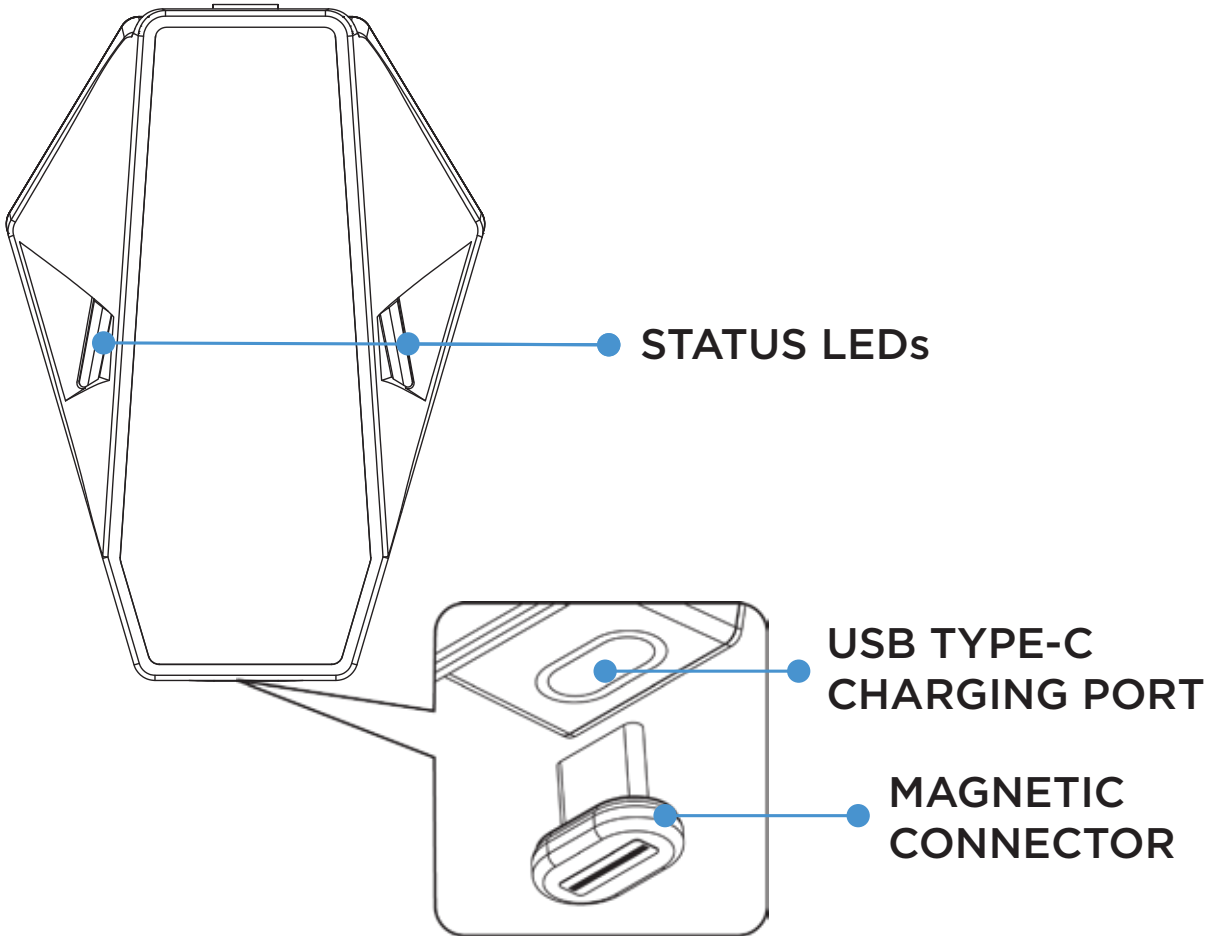

### TSTICK

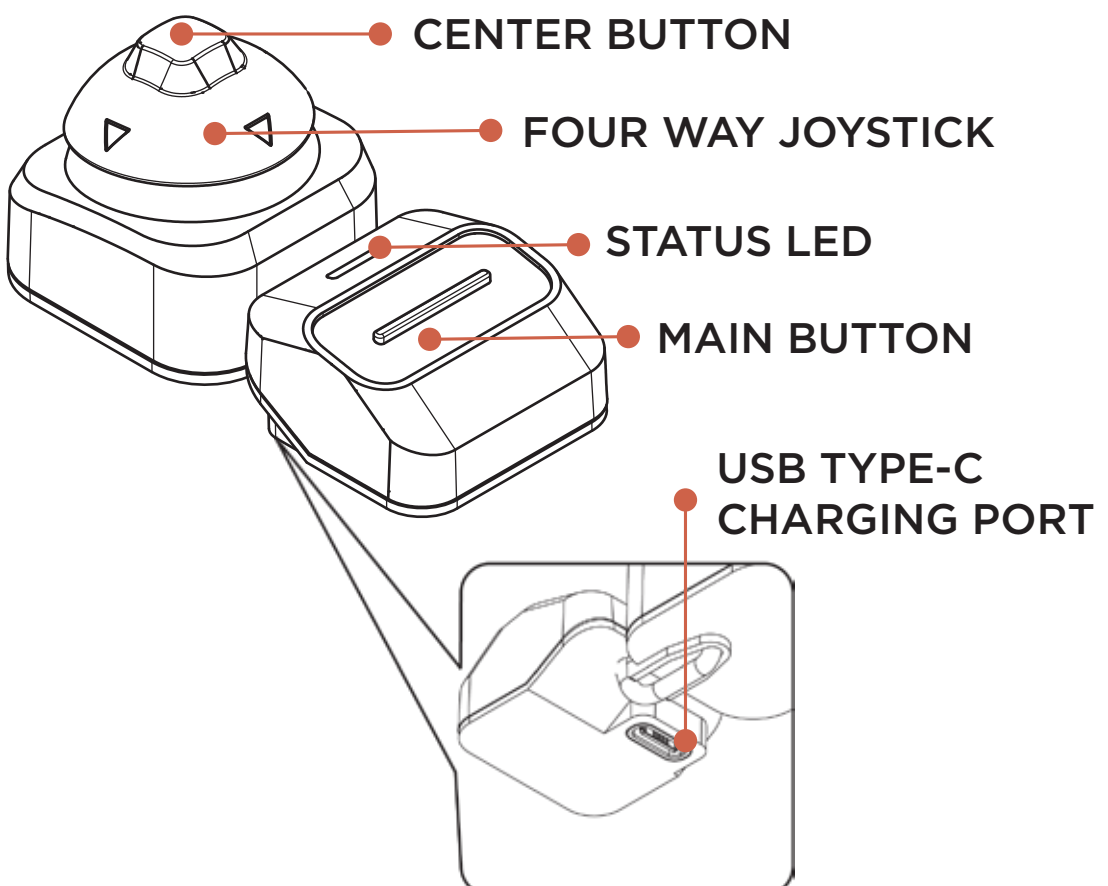



# Installation Steps

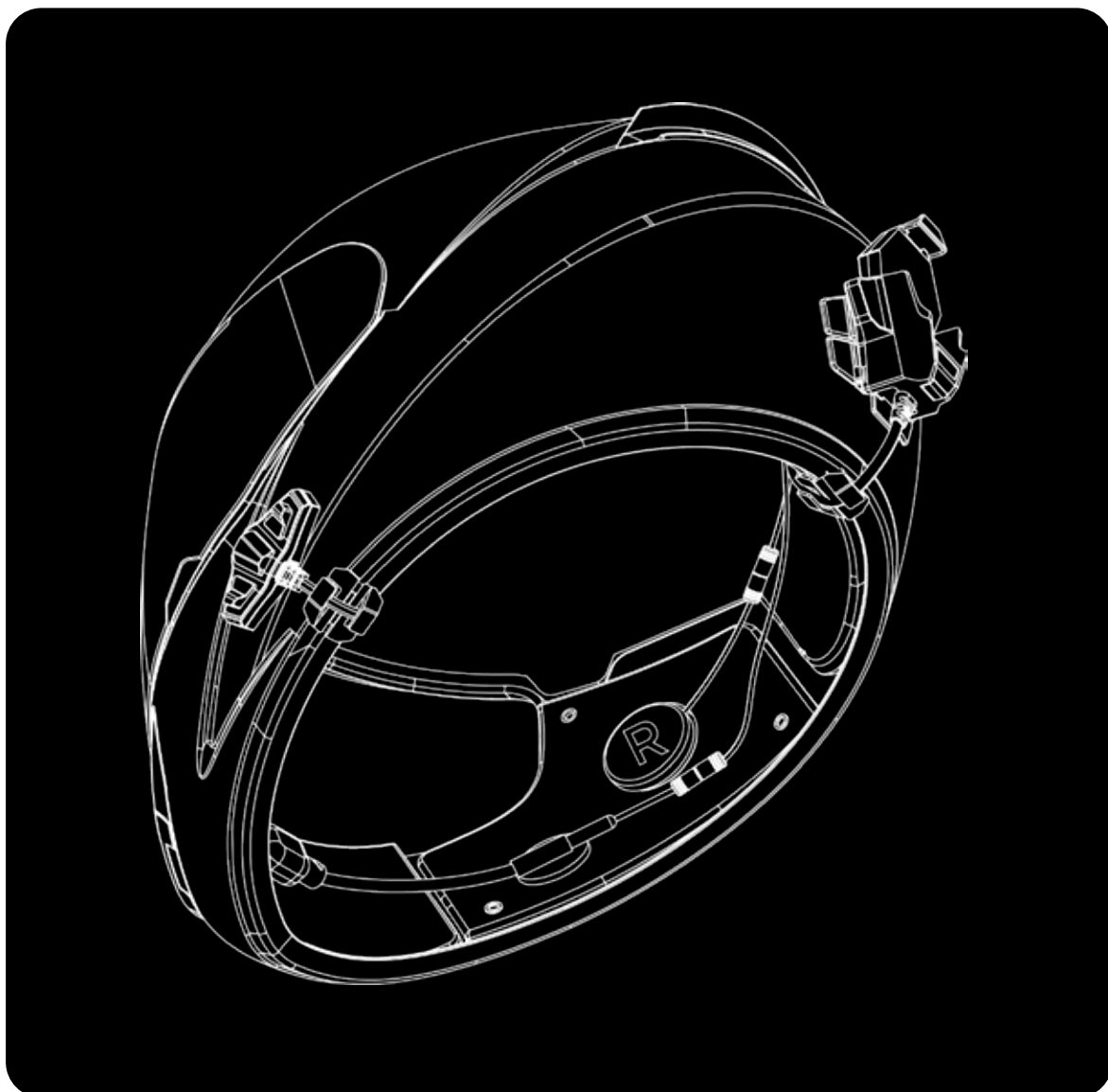

**01** - HEADSET KIT PLACEMENT

*a - 3 BUTTON MODULE*

**02** - CONNECTING THE COMPONENTS  
TO THE HARNESS

**03** - MAGDOCK PLACEMENT

**04** - CLICKDOCK PLACEMENT

**05** - TSTICK PLACEMENT



**WATCH  
ALL VIDEOS**

UNBOXING &  
INSTALLATION

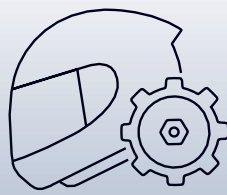

01

## HEADSET KIT PLACEMENT

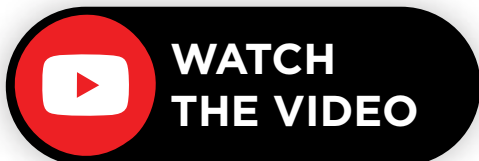

Start by installing the headset. And before you install the headset, you need to remove the helmet inner padding to reveal the speaker slots.

NOTE - MOST HELMETS PROVIDE A SPEAKER SLOT. IF YOUR HELMET DOES NOT HAVE A SPEAKER SLOT, YOU WILL NEED TO PUSH THE EAR-PIECE INTO PLACE ON THE EPS (THERMOCOL) LAYER.

### HEADSET KIT INSTALLATION

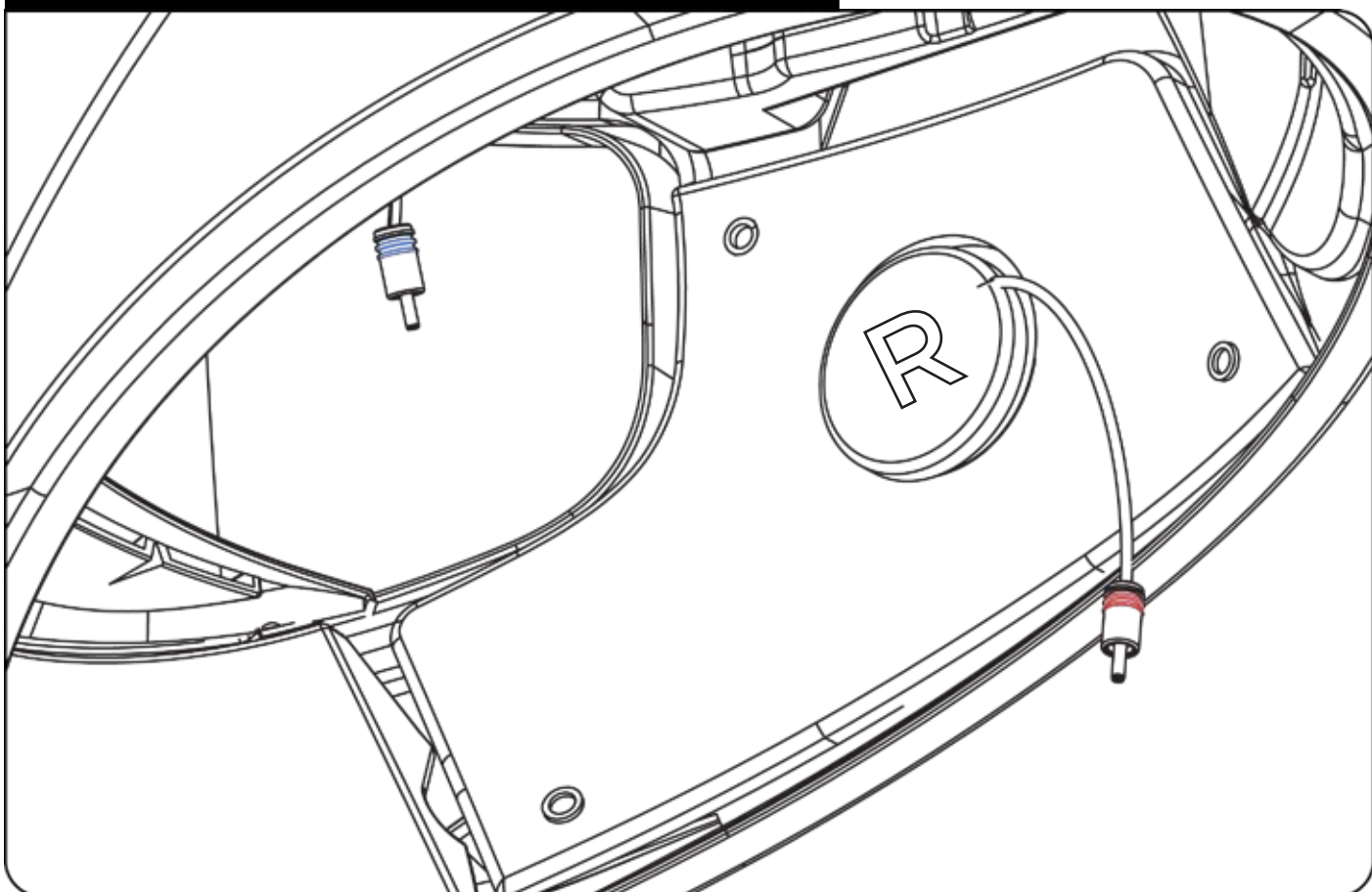

- Take the helmet speakers and the velcro stickers.
- Locate the slots provided inside the helmet.
- Remove the release liner from the speaker velcro and paste it in the speaker slot along with the speaker.
- Use additional spacers to center the speakers and position them close to your ears.
- Adjust the speaker position later when testing the audio output.





Now for the mic, you have two options,

**The Button Mic and The Boom Mic.**

If you have a full face helmet, we recommend The Button Mic, if you have a modular helmet or an open face helmet we recommend using The Boom Mic.

### MIC INSTALLATION

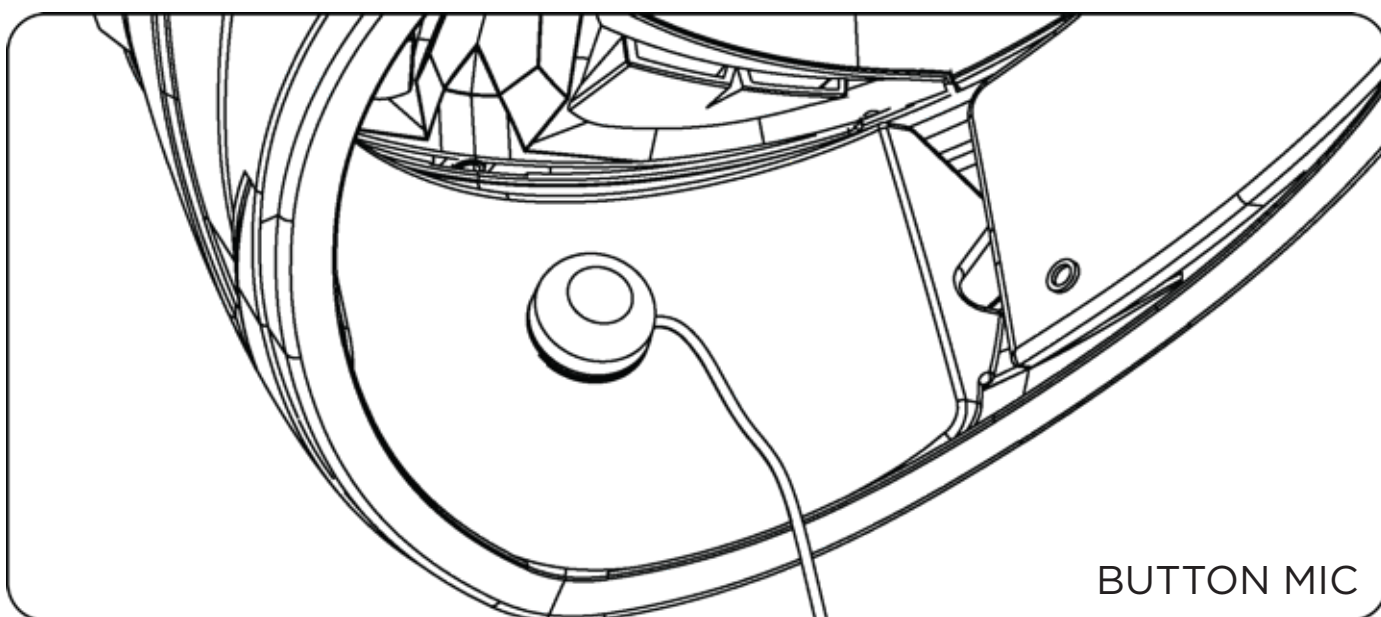
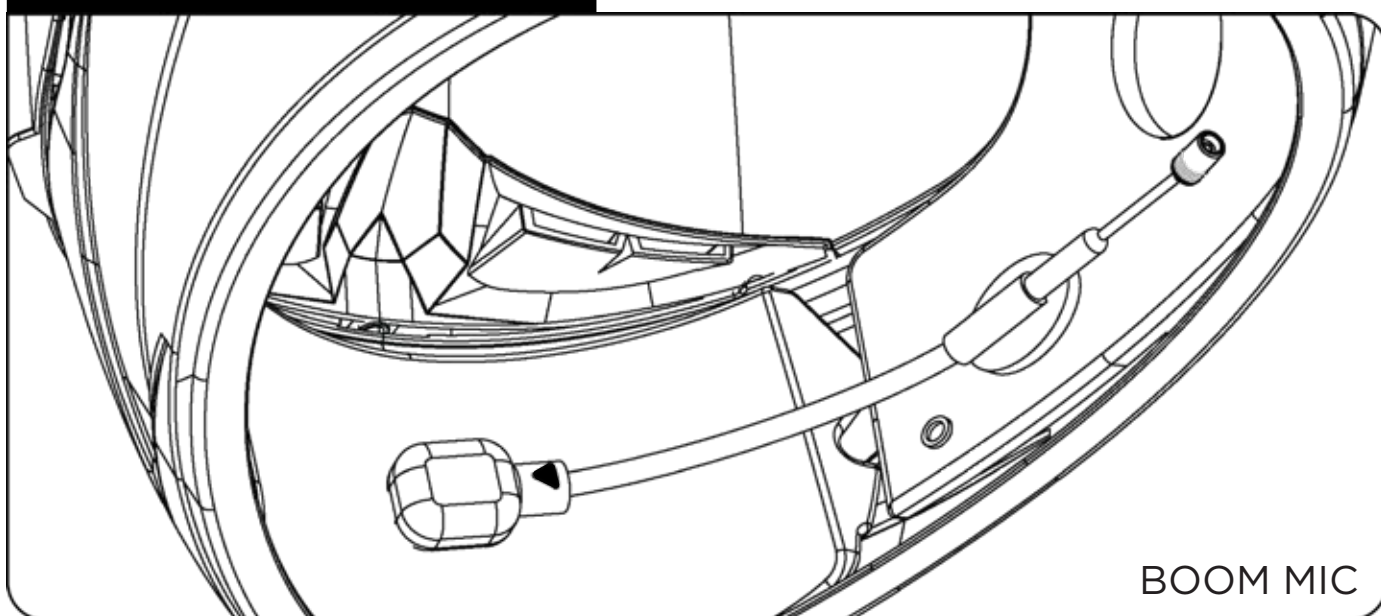

- Run the mic along the left inner surface of the chin bar, ensuring the arrow on the mic faces toward the mouth.
- Adjust the mic so that it is close to your mouth.
- Use the flexible stem to position the mic for comfort.
- Make further adjustments as needed for optimal placement.



## a - 3 BUTTON MODULE

Now let's install the 3 Button Module

### 3 BUTTON MODULE INSTALLATION

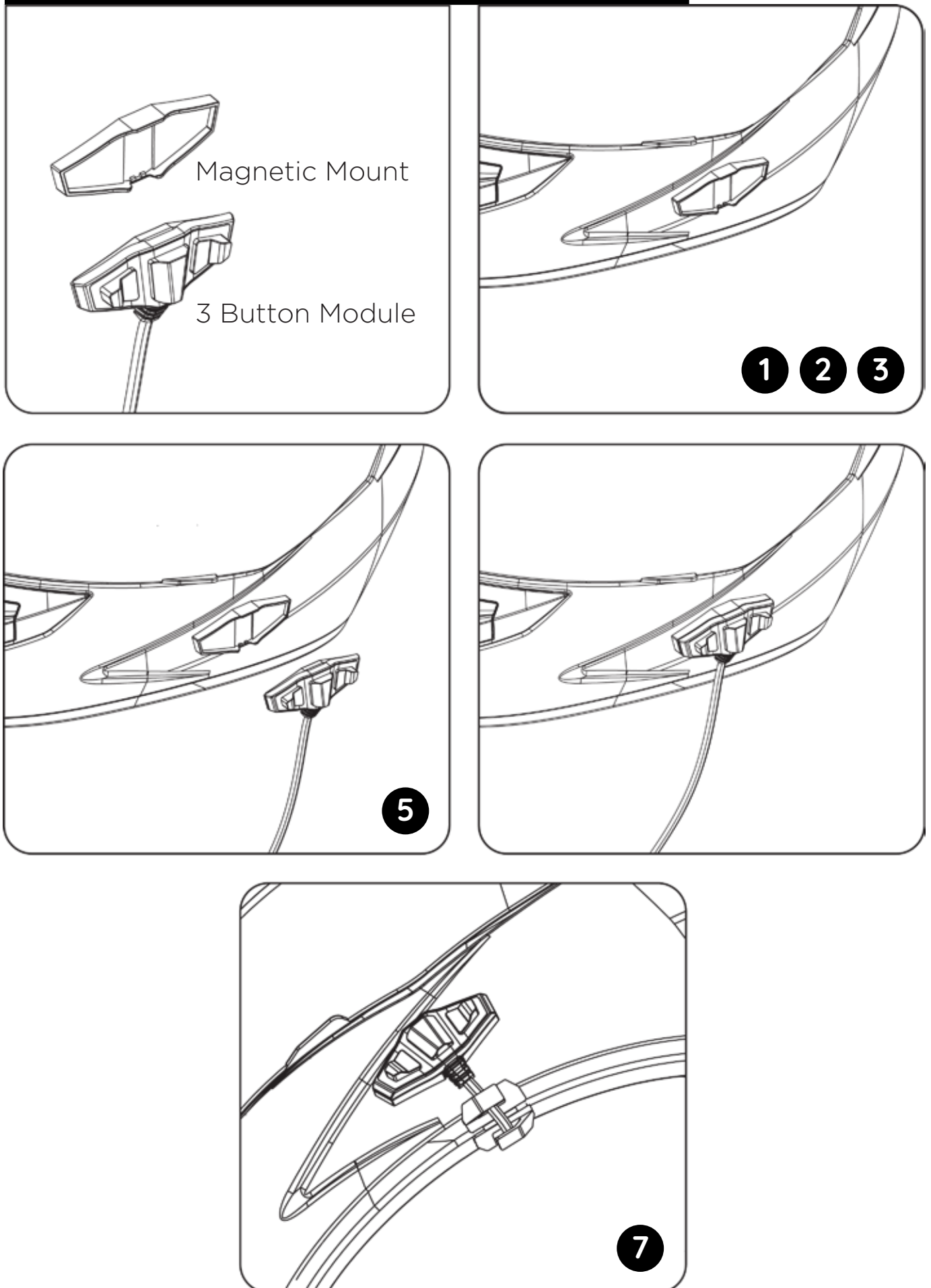

1. Take the magnetic mount of the 3-button module.
2. Place it on the left side of your helmet in a position easily reachable by your left hand.
3. Once the position is fixed, peel off the sticker from the mount.
4. Stick the mount to the helmet at least 20 minutes before your ride.
5. Attach the 3-button module to the mount
6. Run the cable through the groove of the helmet pad
7. Finally attach the cable manager.

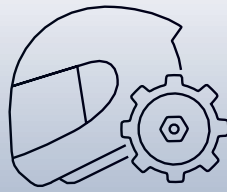

02

## CONNECTING THE COMPONENTS TO THE HARNESS

Now, **connect** the **installed headset, mic,** and **3-button module** to the **wire harness, matching connectors by color and form.**

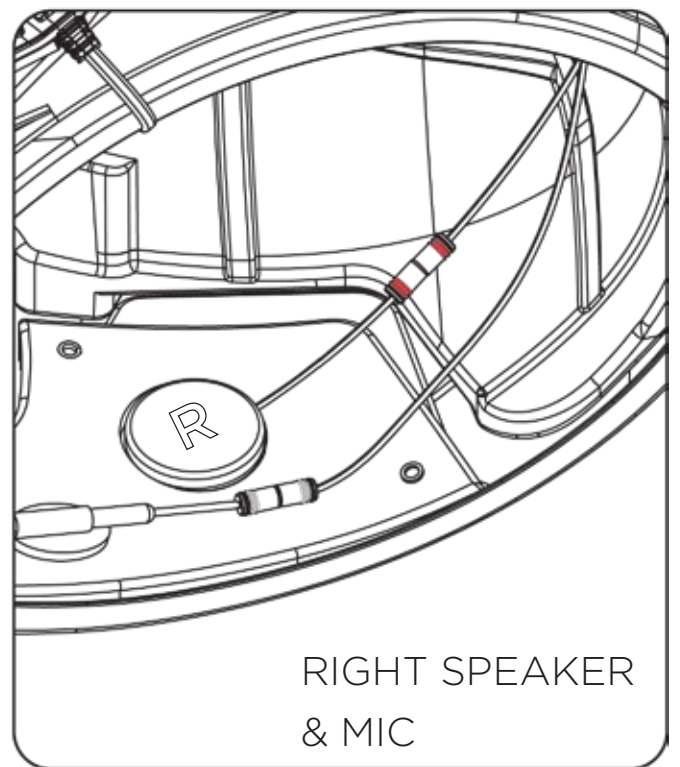
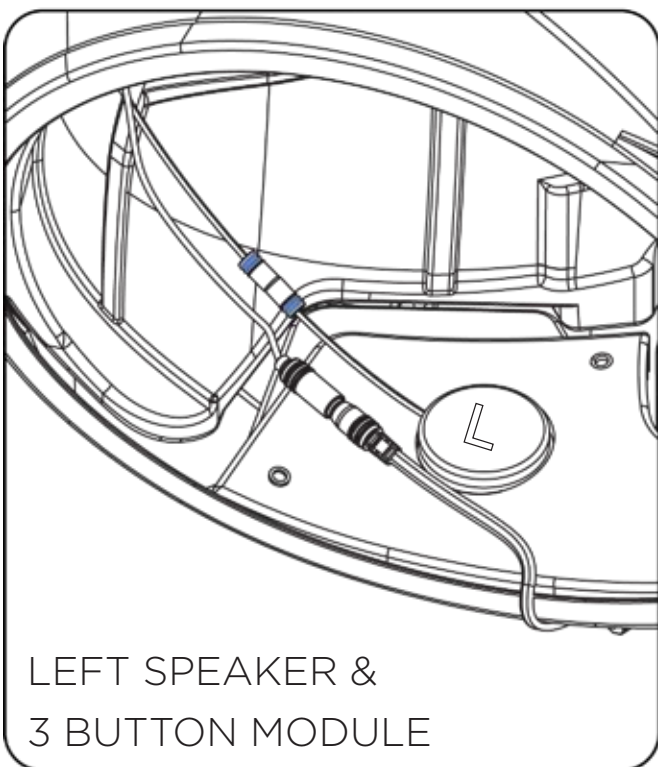
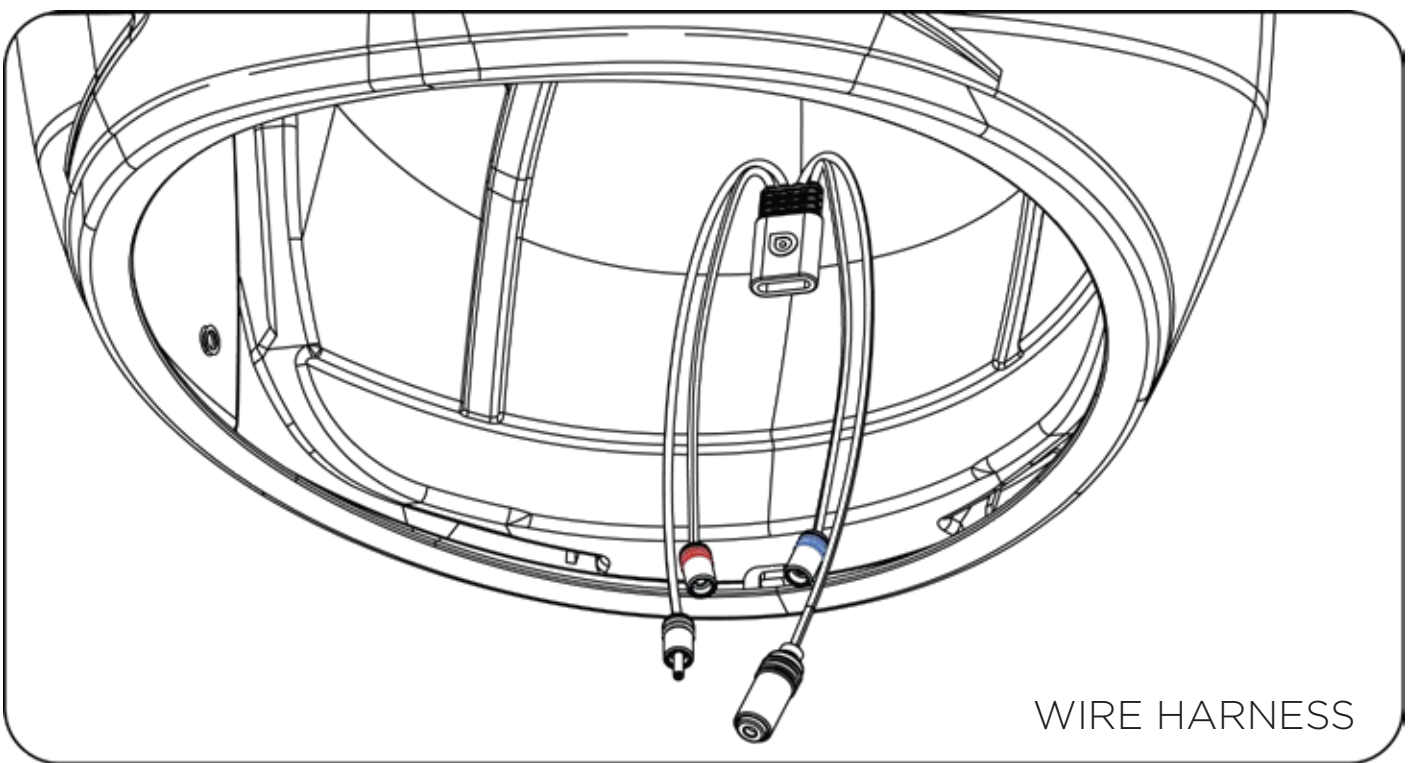

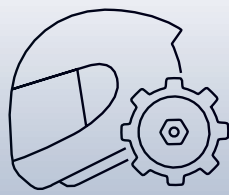

03

## MAGDOCK INSTALLATION



There are two ways through which you can install the MagDock.

**Directly with the VHB or as a removable option with the WingMount.**

If you prefer not removing the MagDock ever from this helmet, then it is best to stick it down with the VHB adhesive. This will be a slightly slimmer setup.

However if you think you would like to swap the MagDock with the ClickDock or swap the whole setup on to another helmet then the Wing Mount option is the right choice for you

Follow the instructions below and choose the option best suited to you.

### a - VHB MOUNT OPTION

Clean the helmet surface well prior to sticking the mount. Remove the white release sheet on the VHB and stick it to the rear of the MagDock as shown below.

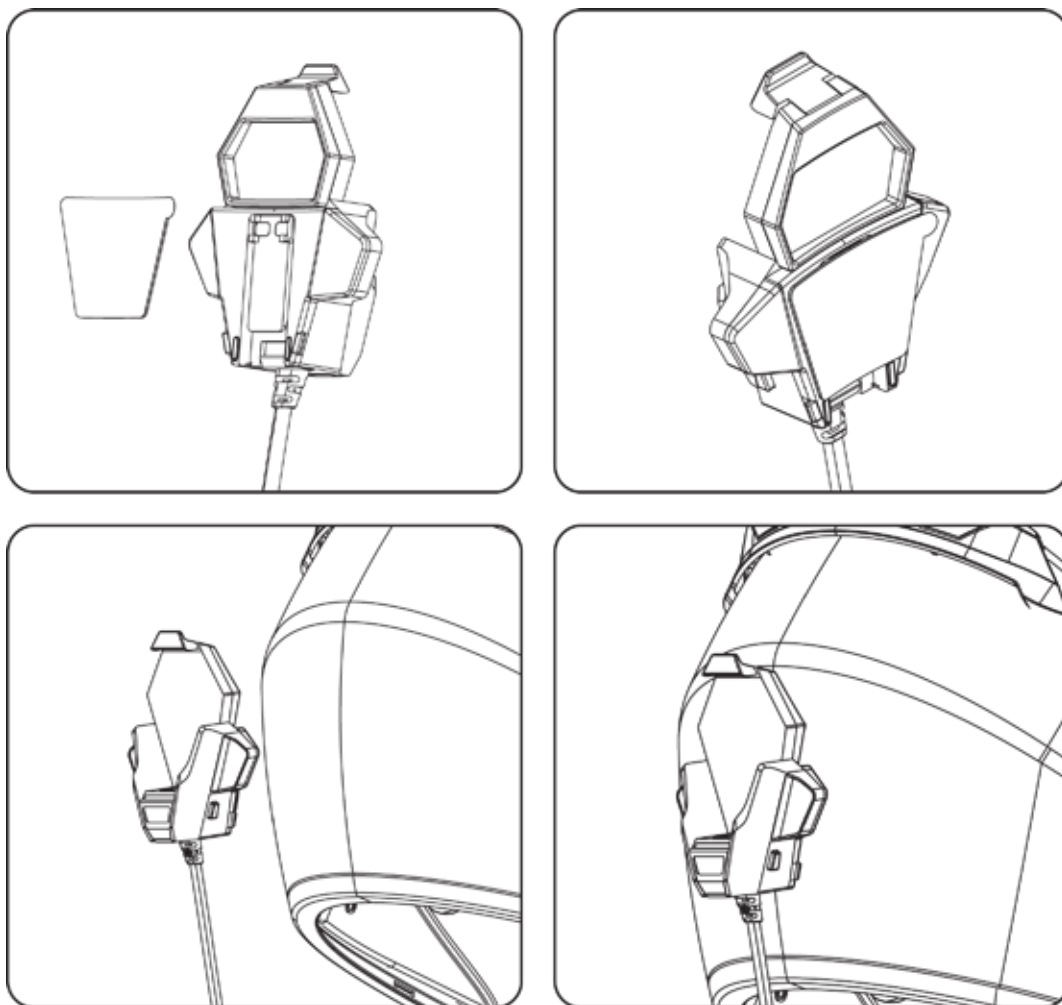



- Place the MagDock on the helmet to find the ideal mounting position.
- Once positioned, clean the surface of dust, stains, oil, or dirt.
- Peel off the red release liner.
- Ensure the mount is centered.
- Stick the MagDock to the helmet

## b - WING MOUNT

First dock the MagDock to the wing mount and place it on the helmet such that you are able to push the release tab at the bottom of the wing mount to remove the MagDock. There should be enough space under the tab to be able to push it down fully to release the MagDock.

Once you are certain the location allows for this movement, ensure that the surface of the helmet is clean, then Install the wing mount by removing the red release liner and sticking it down.

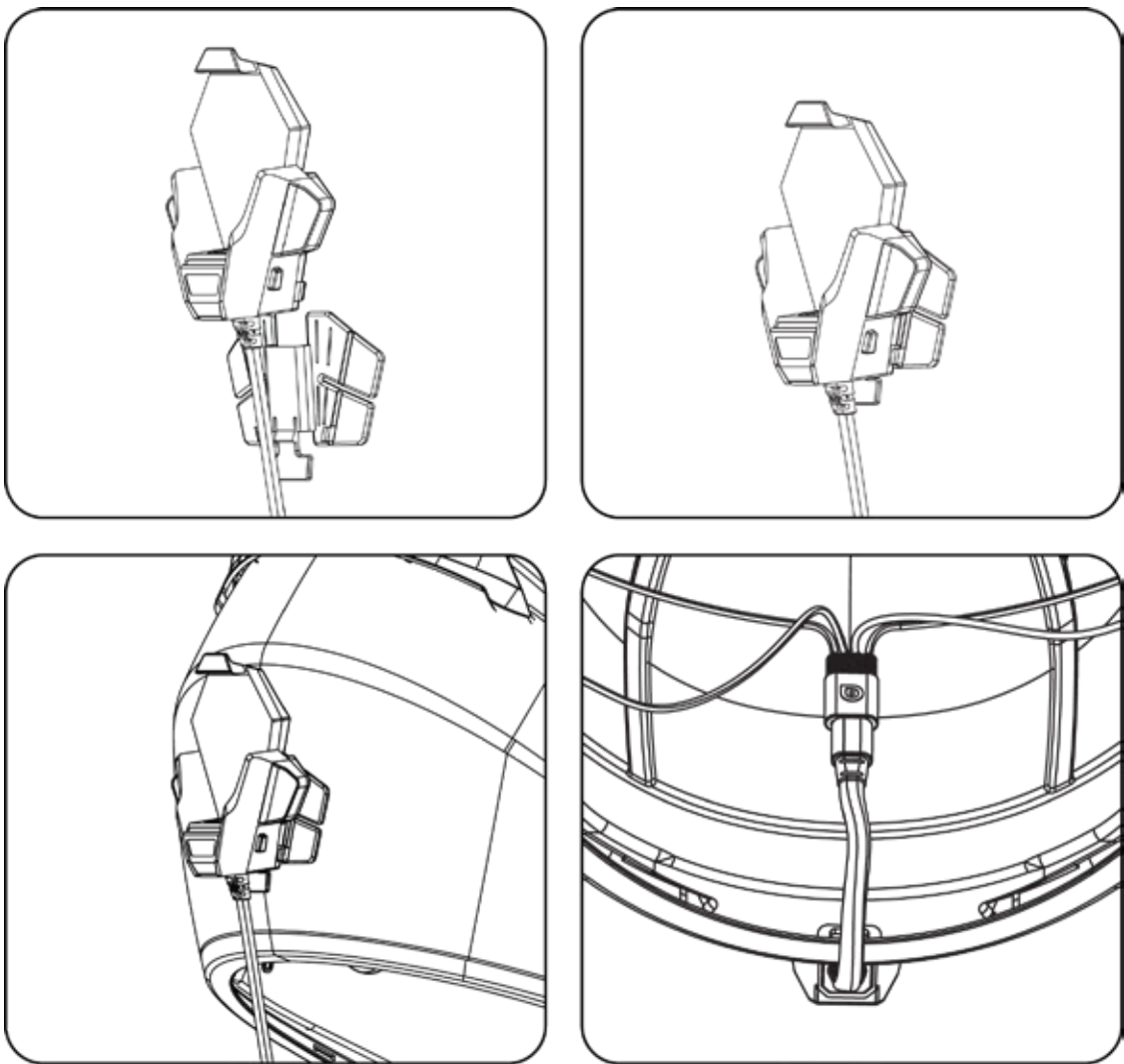

- Insert the MagDock cable through the cable manager.
- Remove the red release liner from the adhesive sticker.
- Stick the cable manager in place.

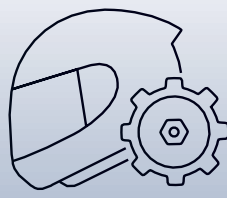

04

## CLICKDOCK INSTALLATION



There are two ClickDocks provided with the C50 Pro bundle. One meant for the **wing mount** and the other with **VHB pre-installed**.

Follow the instructions below and choose the option best suited for your helmet.

### a - WING MOUNT

- Assemble the wing mount to a compatible ClickDock.
- Position the assembly on the helmet.
- Ensure you can push the release tab at the bottom of the wing mount to remove the ClickDock.
- Leave enough space under the tab for full movement.
- Clean the helmet surface where the wing mount will be installed.
- Remove the red release liner.
- Stick the wing mount onto the helmet.

Slide the ClickDock onto the wing mount and click it in place as shown below.

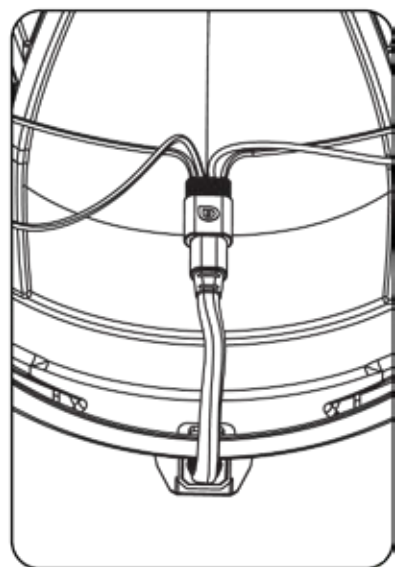
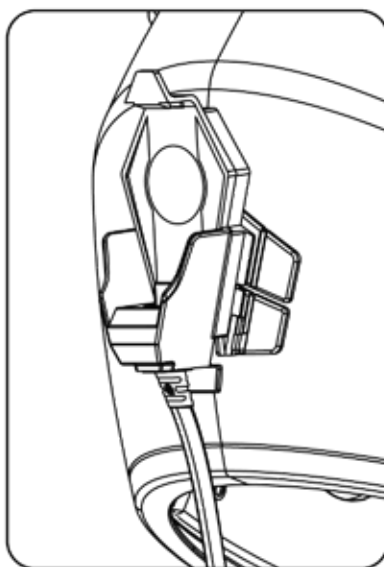
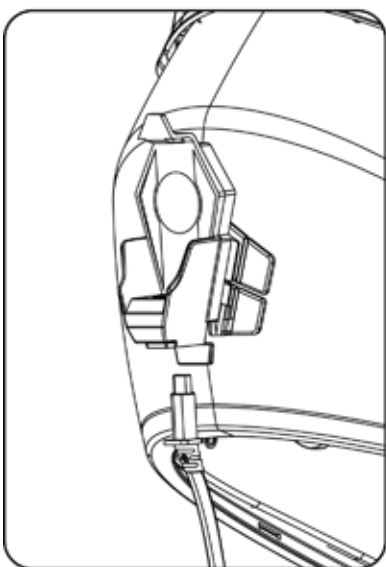
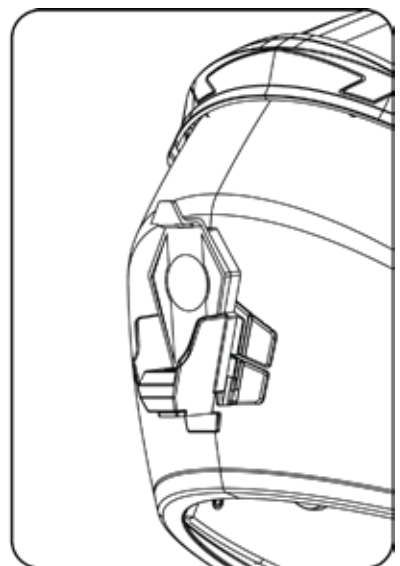
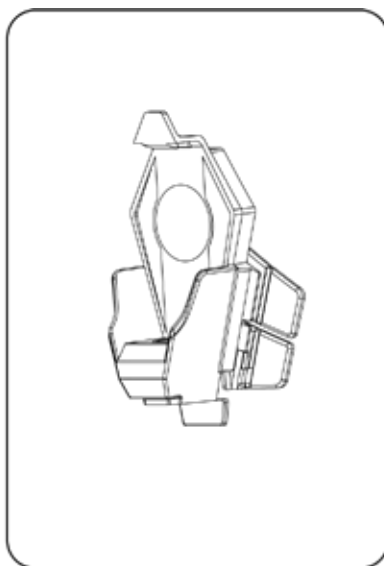
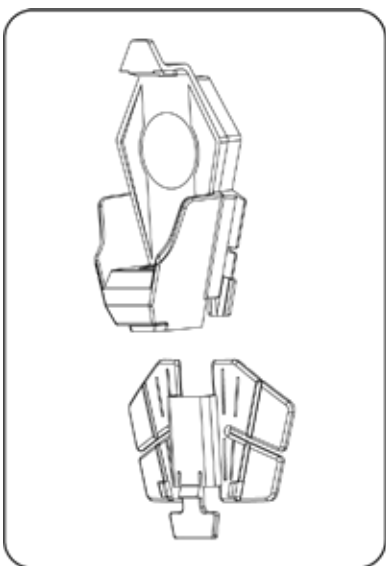



## b - VHB MOUNT OPTION

- The ClickDock comes with a top and bottom VHB sticker on the rear.
- Remove the VHB release liner from the bottom first.
- Ensure the helmet surface matches the ClickDock curvature at the top.
- If aligned properly or needed, remove the top release liner of the VHB and stick the ClickDock.

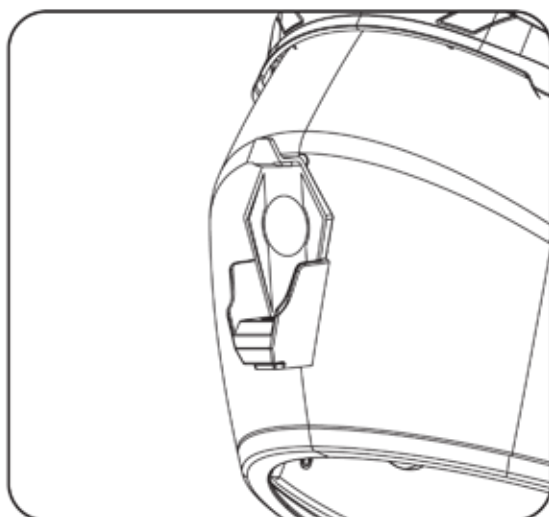
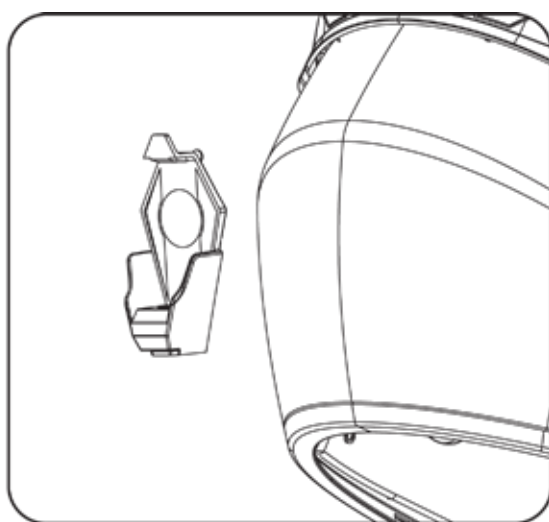
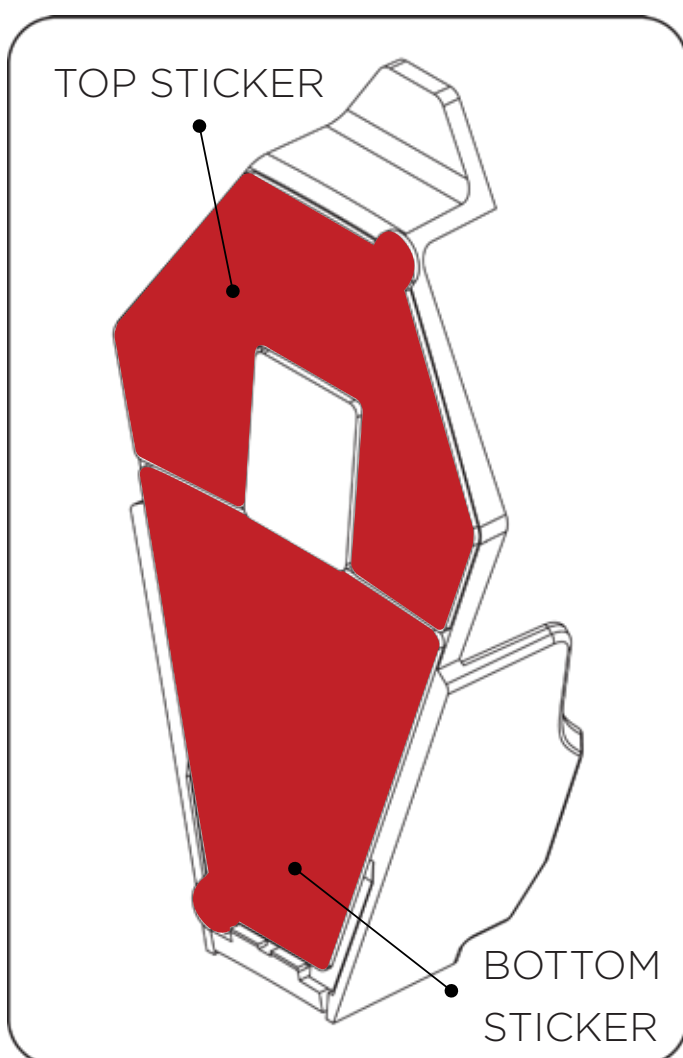

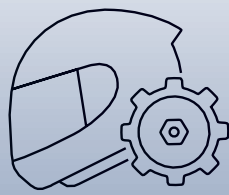

05

## TSTICK INSTALLATION

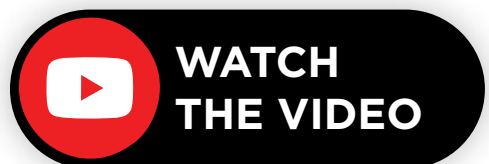

**Strap Mount** and **Velcro Mount** are the two mounts provided for the Tstick, with the C50 Pro

Follow the instructions below and choose the option best suited for your helmet.

### a - STRAP MOUNT

Start by mounting the TStick into the Strap mount bracket as shown below.

The velcro mount will keep the TStick stuck to the strap while the brackets keep it secure from moving during operation.

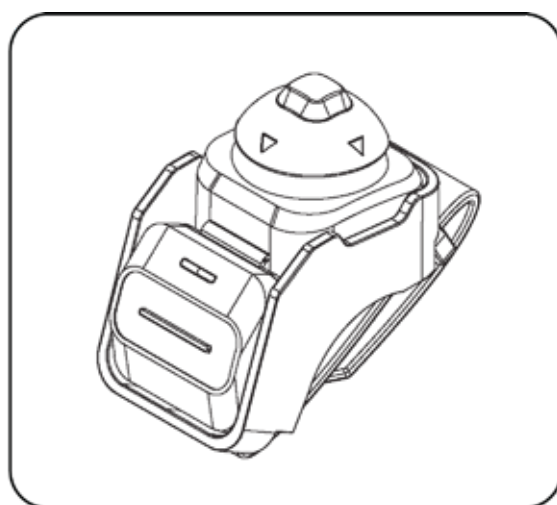
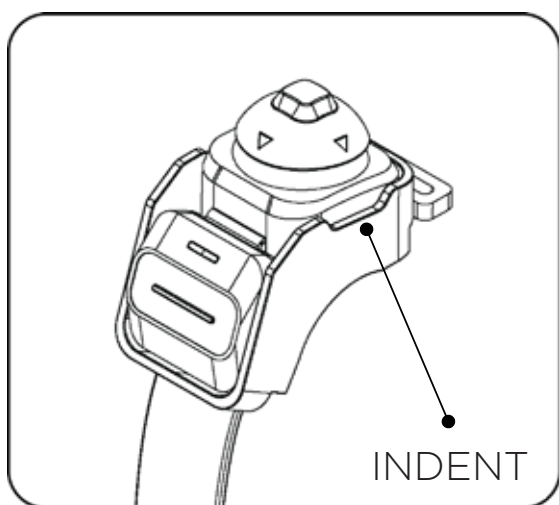

NOTE - THE FOUR WAY JOYSTICK MUST BE PLACED IN THE SIDE OF THE MOUNT WHERE THERE IS AN INDENT ON THE BRACKET

Choose a reachable spot on the handlebar or the handlebar grip and attach the strap mount

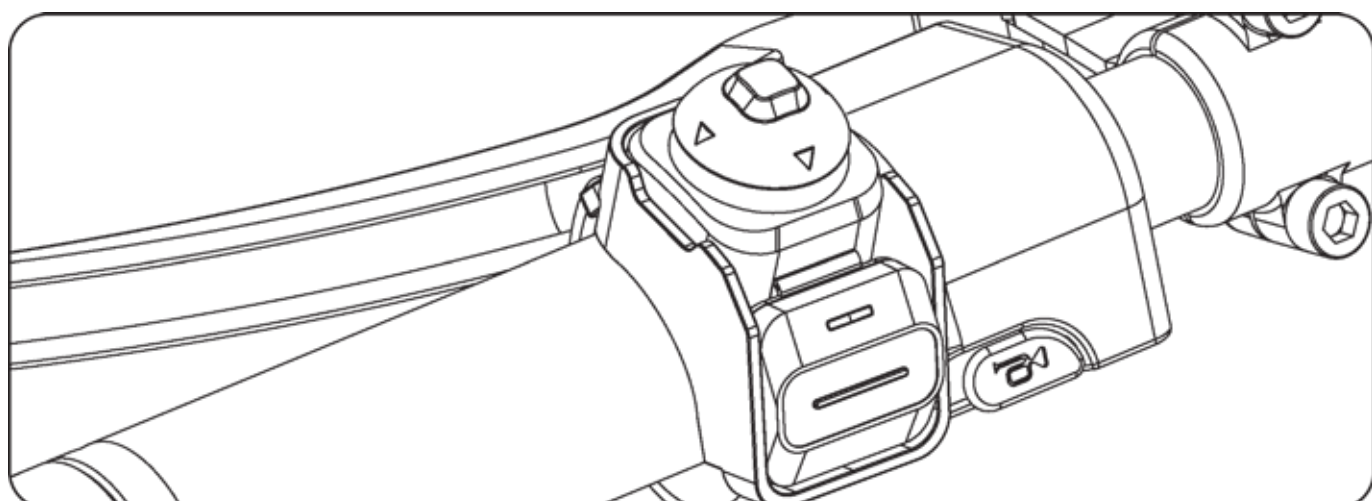

Choose your preferred orientation and set it in the BluArmor Comm app while pairing the TStick to ensure correct button functions.





## b - VELCRO MOUNT

The Velcro Mount can be used to mount the TStick on the tank/any other relatively flat surface that you might prefer.

- Clean the surface well prior to sticking the mount.
- Peel off the red release liner of the velcro mount and stick it on the tank

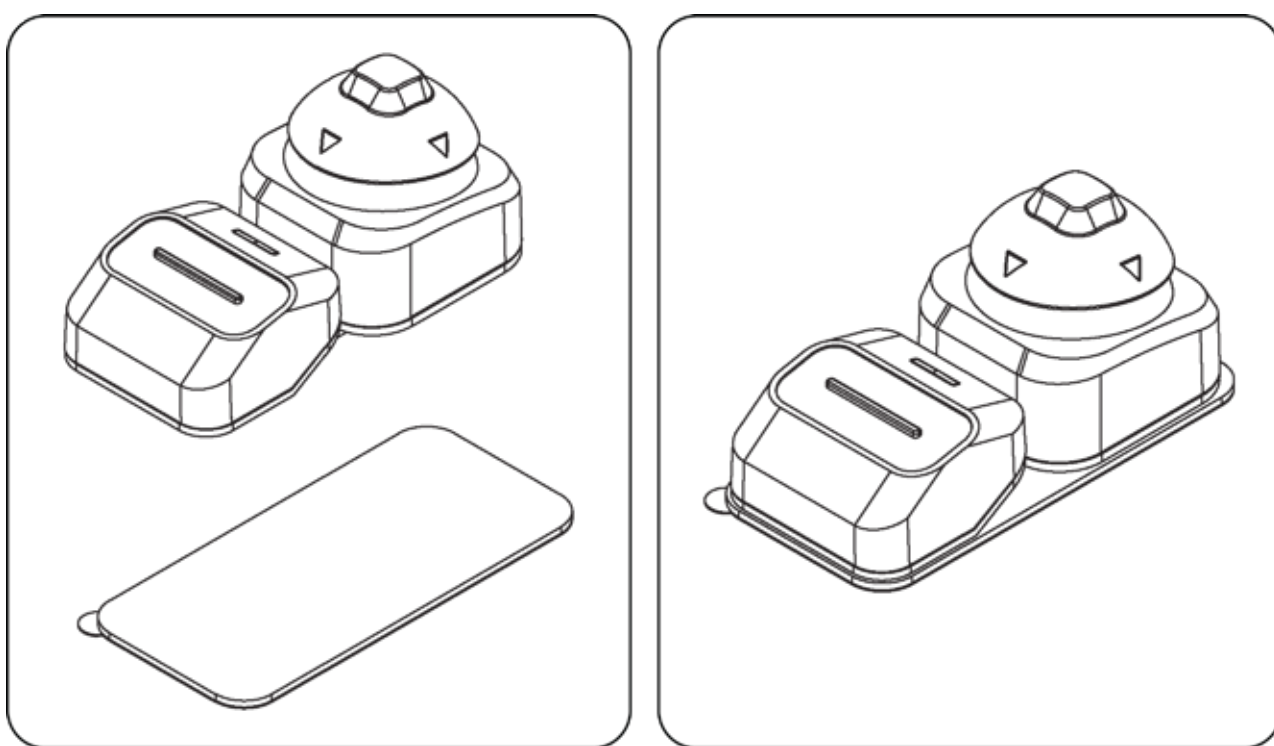

Stick the TStick on the velcro mount in any orientation comfortable and select the orientation on the app

Refer to **GETTING STARTED** section in this user manual to learn more about the TStick

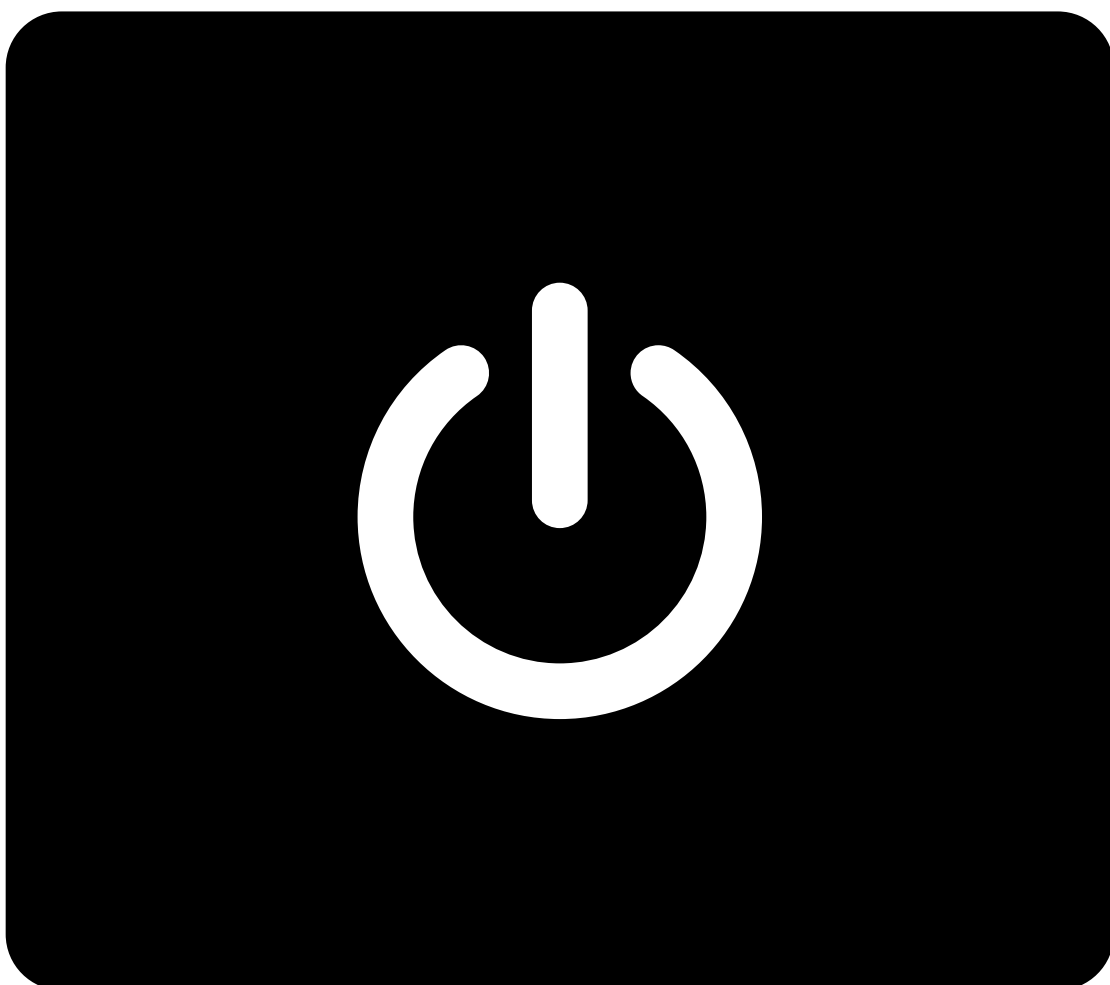

## **01** - CHARGING

*a* - THE MAIN UNIT

*b* - THE TSTICK

## **02** - PAIRING C50 TO PHONE

## **03** - CONNECTING THE APP

## **04** - BUTTONS AND FUNCTIONS

*a* - 3 BUTTON MODULE

*b* - TSTICK

## **05** - PAIRING SECOND DEVICE

## **06** - PAIRING AND USING THE TSTICK

## **07** - OTA FIRMWARE UPDATE



# 01 CHARGING

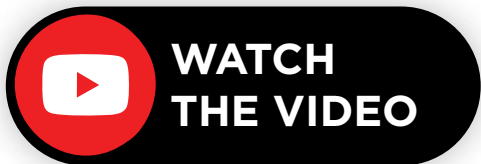

Both the **Main Unit** and the **TStick** is equipped with a Type-C slot to charge them.

## a - THE MAIN UNIT

We recommend you use the magnetic charging adapter to charge the device for ease of use.

The box comes with a charging cable and the adapter.

NOTE - DO NOT USE THE CLICKDOCK CABLE FOR CHARGING, AS IT IS NOT COMPATIBLE. IT IS DESIGNED TO BE USED SOLELY AS PART OF THE HEADSET KIT.

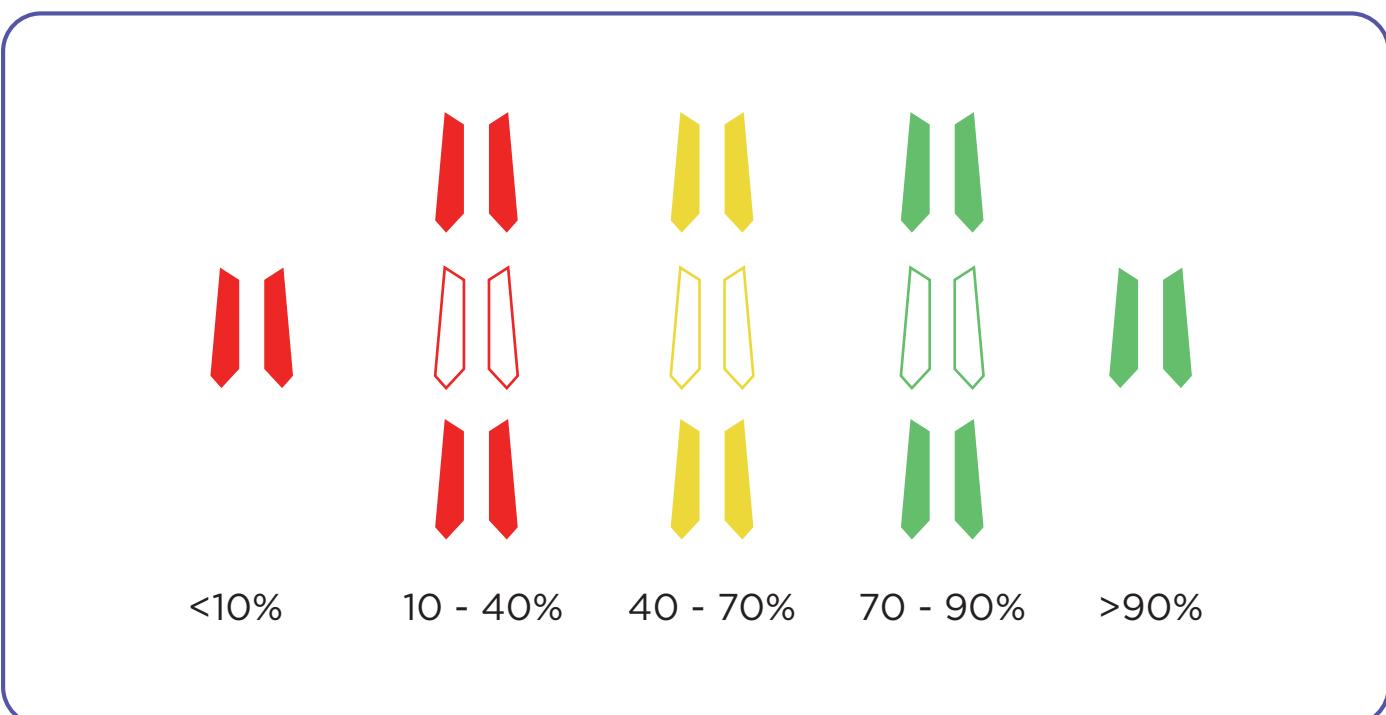
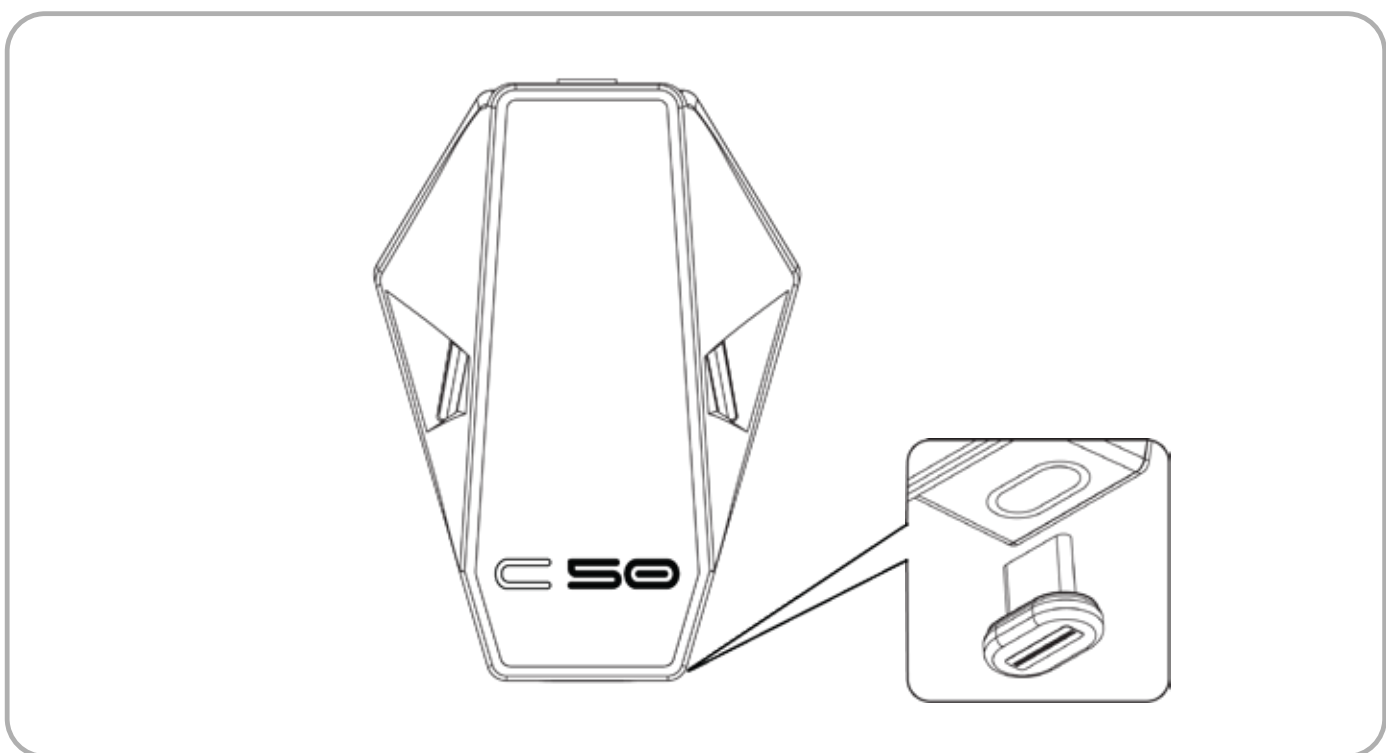

LED CHARGING INDICATIONS



## b - THE TSTICK

The TStick can be charged through the USB Type-C port provided under the device.

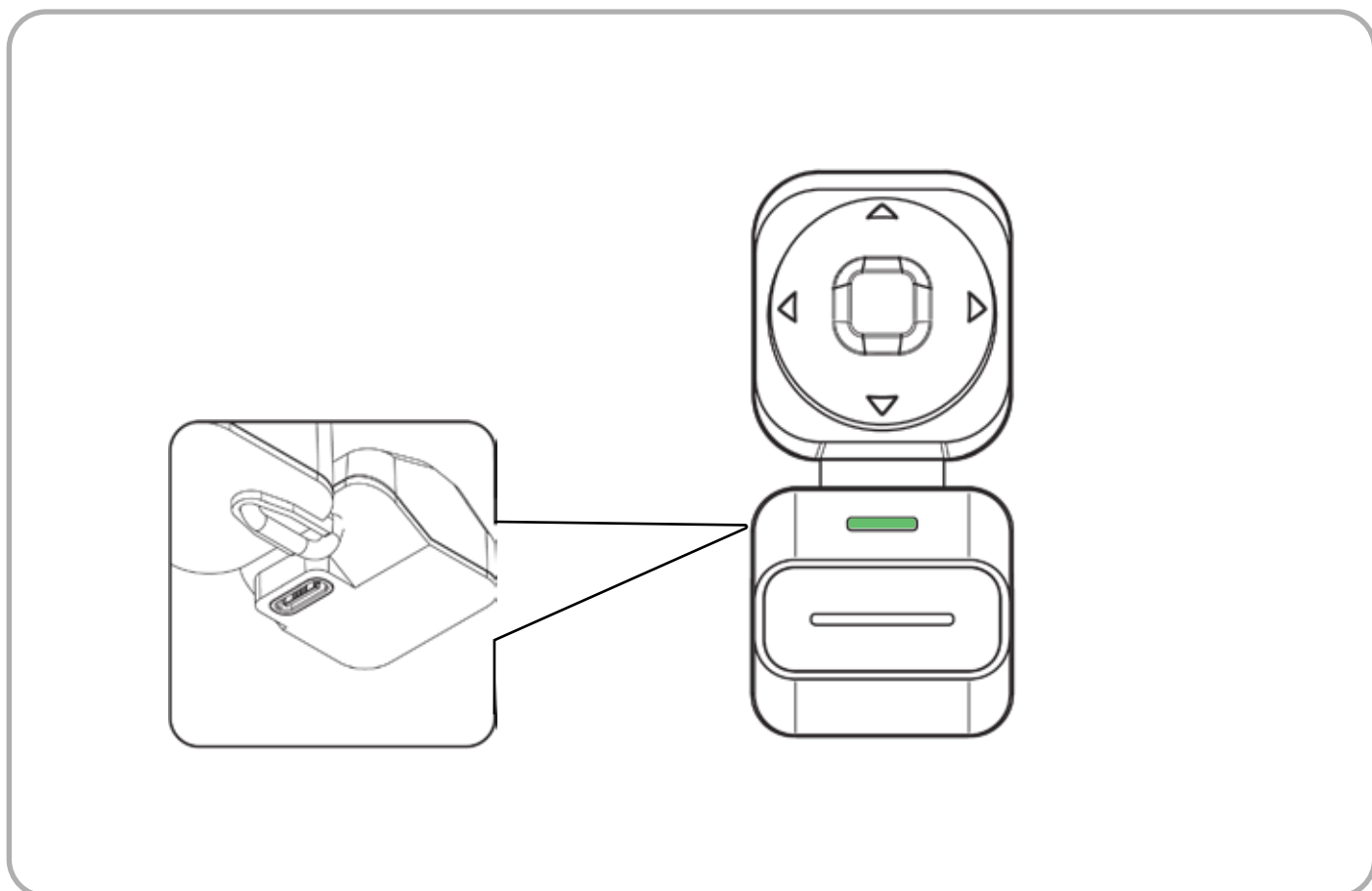

THE LED INDICATOR WILL LIGHT UP GREEN WHILE ON CHARGE  
AND WILL TURN OFF ONCE FULLY CHARGED

LED CHARGING INDICATIONS



02

## PAIRING C50 TO PHONE



For the best experience, we recommend using the app.

However, the **C50** can also **connect** to your phone via **Bluetooth Classic** for **basic functions** such as phone calls, music, and navigation.

When you **turn on** the **device** for the **first time**, the **main unit** will automatically enter **Bluetooth pairing mode**.

When you need to **pair the device again** to a mobile phone, **click** the **centre button** of the 3 button module **thrice**

**PAIRING MODE**  
(ENTER/EXIT)

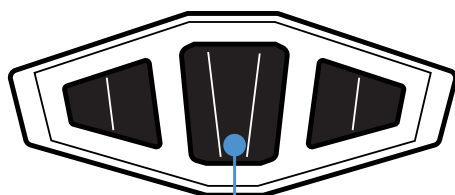

PRESS THRICE

The status LED will start blinking blue to indicate that it is now in advertising mode.

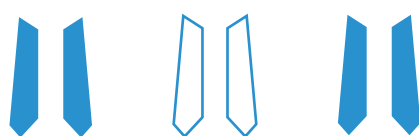

ADVERTISING MODE

Complete pairing and allow contact access on your phone. You need to do this only the first time. Device will auto-connect to the last connected phone.



03

## CONNECTING THE APP

For the full range of features of the C50 to work, you will need to install the **BluArmor App** on your phone. The app is also useful to access the customer support links from the app if you need additional help or guidance.

Both Android and iOS devices are supported.

Install the app and follow the steps inside the app to complete the process.

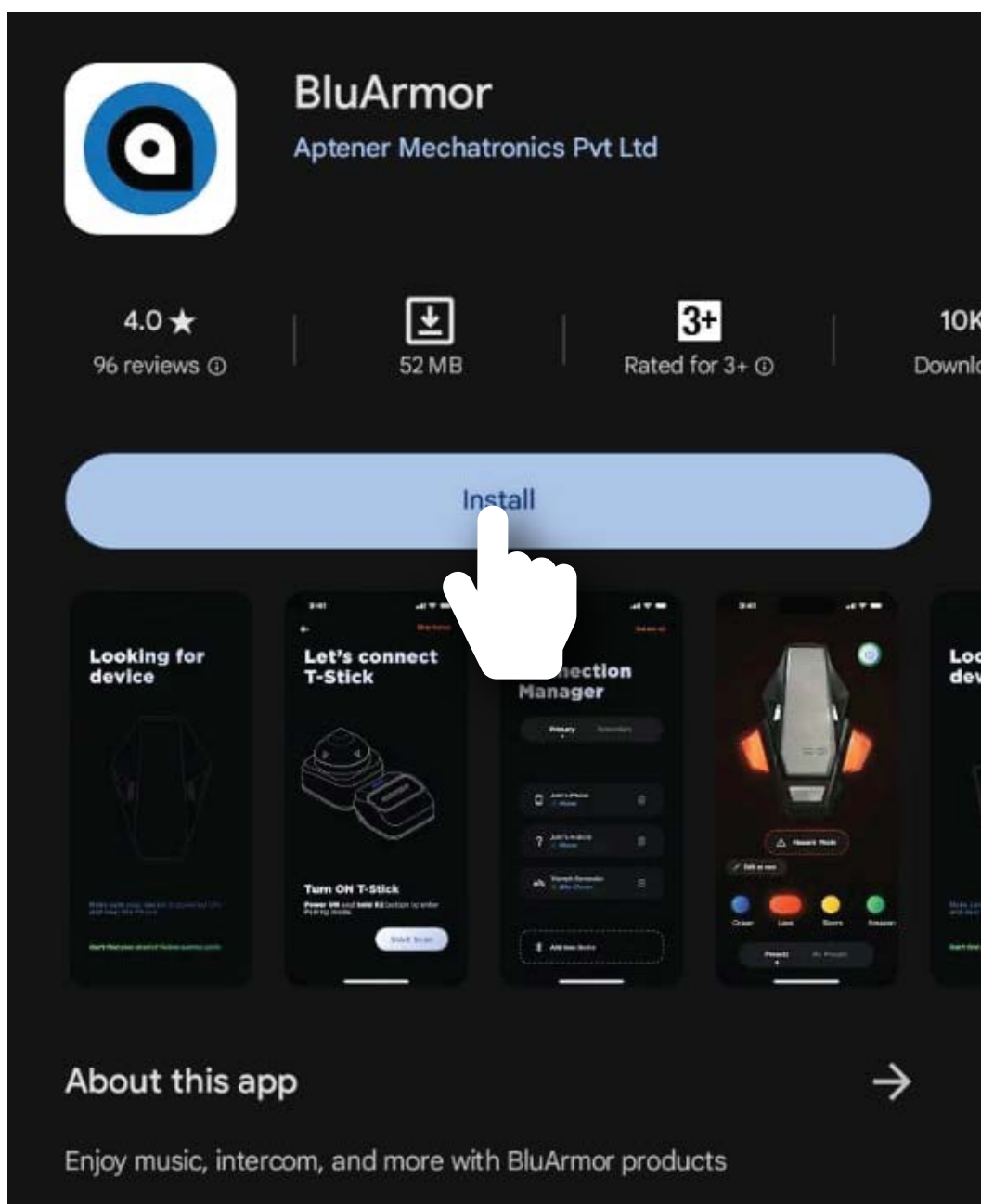



04

## BUTTONS AND FUNCTIONS

### 3 BUTTON MODULE

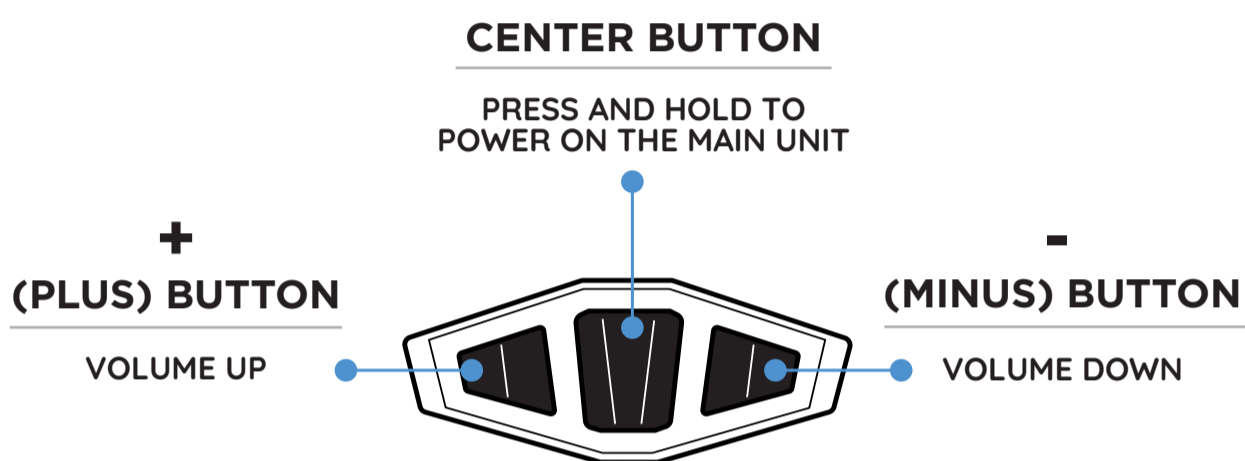

### TSTICK

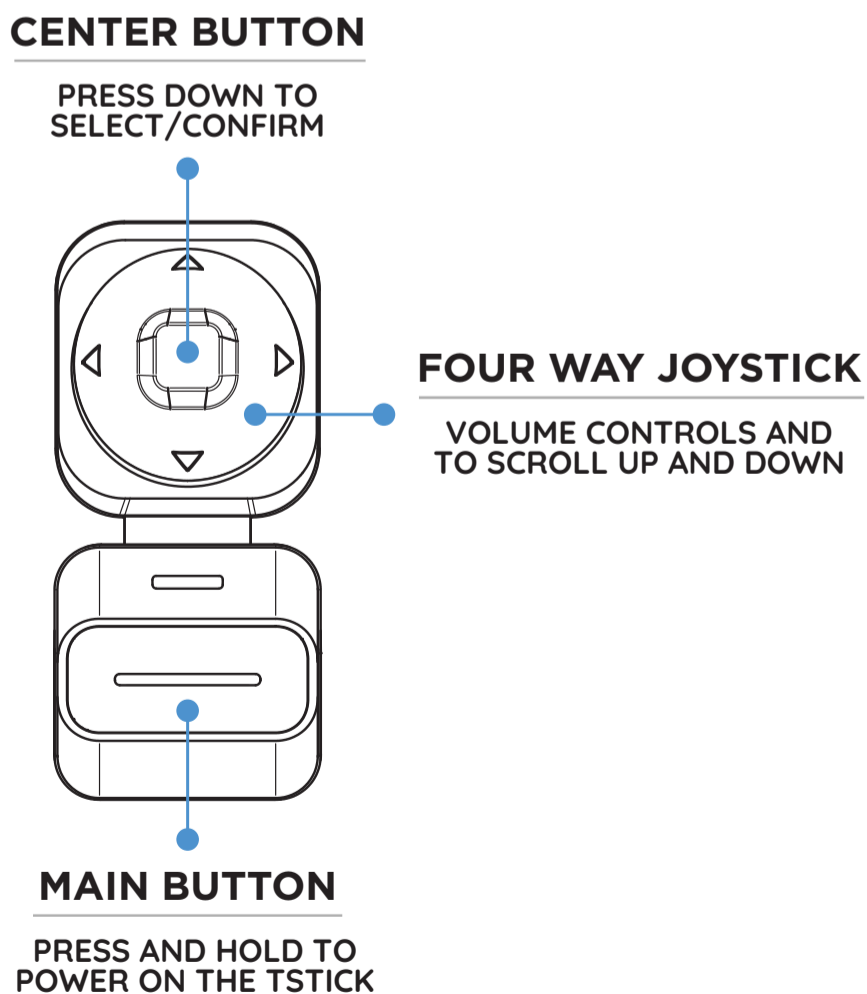



05

## PAIRING SECOND DEVICE

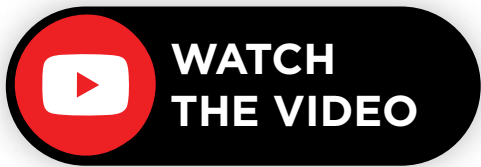

Once you are connected to your first phone, you have the option to connect a second device too. And you can do so in the given ways below..

### a - VIA 3 BUTTON MODULE

**Triple press** the **'-' (minus)** button on the 3 button module to pair a second device to the C50.

**2ND PHONE PAIRING**  
(ENTER/EXIT)

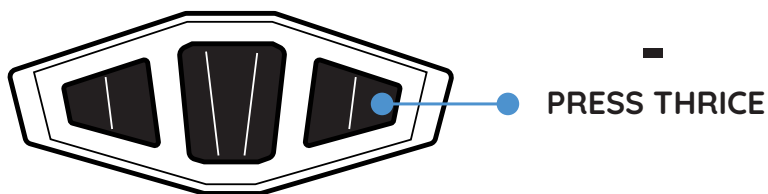

### b - USING THE APP

- **Open Settings:** Go to the settings in the app.
- **Navigate to Connection Manager:** Access the connection manager dashboard.
- **Select Secondary Tab:** Press on the Secondary tab.
- **Add Device:** Click on "Add a device".
- **Pair:** You're now ready to pair a second device to the C50.

Refer under **PORTWEAVE™** section in this user manual on how **add a second device**





06

## PAIRING & USING THE TSTICK



NOTE - THE TSTICK PAIRS WITH C50 AND NOT TO A MOBILE PHONE

Follow the steps shown below to pair the TStick to the C50.

- Turn on the TStick by pressing and holding the main button
- Do a single press on the center button of the 3-button module.
- Immediately follow with a long press on the same button.

### TSTICK PAIRING TO C50

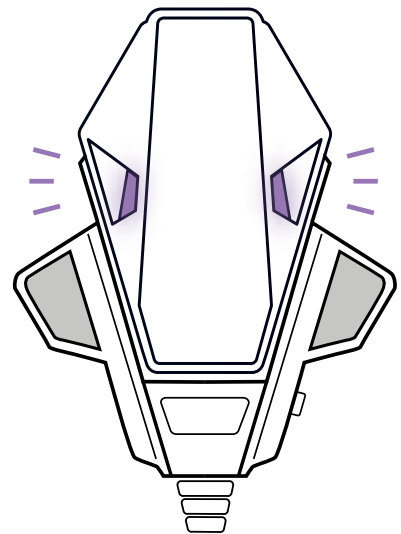
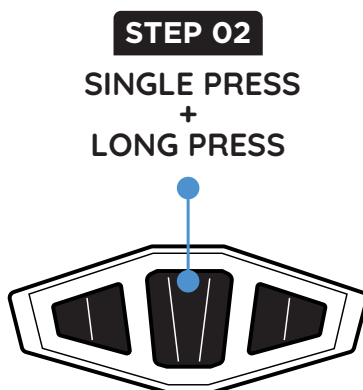

When you power on the TStick, the status LED on the TStick will blink blue in an interval of 5 Secs until it pairs to the C50

At the same time, the C50 will light up purple to indicate that it is searching for the TStick.

The TStick LED will flash purple once upon pairing with C50 and an audio prompt will play "TStick Connected"



07

## OTA FIRMWARE UPDATE



**C50** is continuously updated with newer and better features. These improvements are easily updated **Over-The-Air (OTA)** via the app itself and you don't need any cables or additional docks or devices.

Check the app to see if you need an update. **You will see an alert on the main dashboard if your device requires one.**

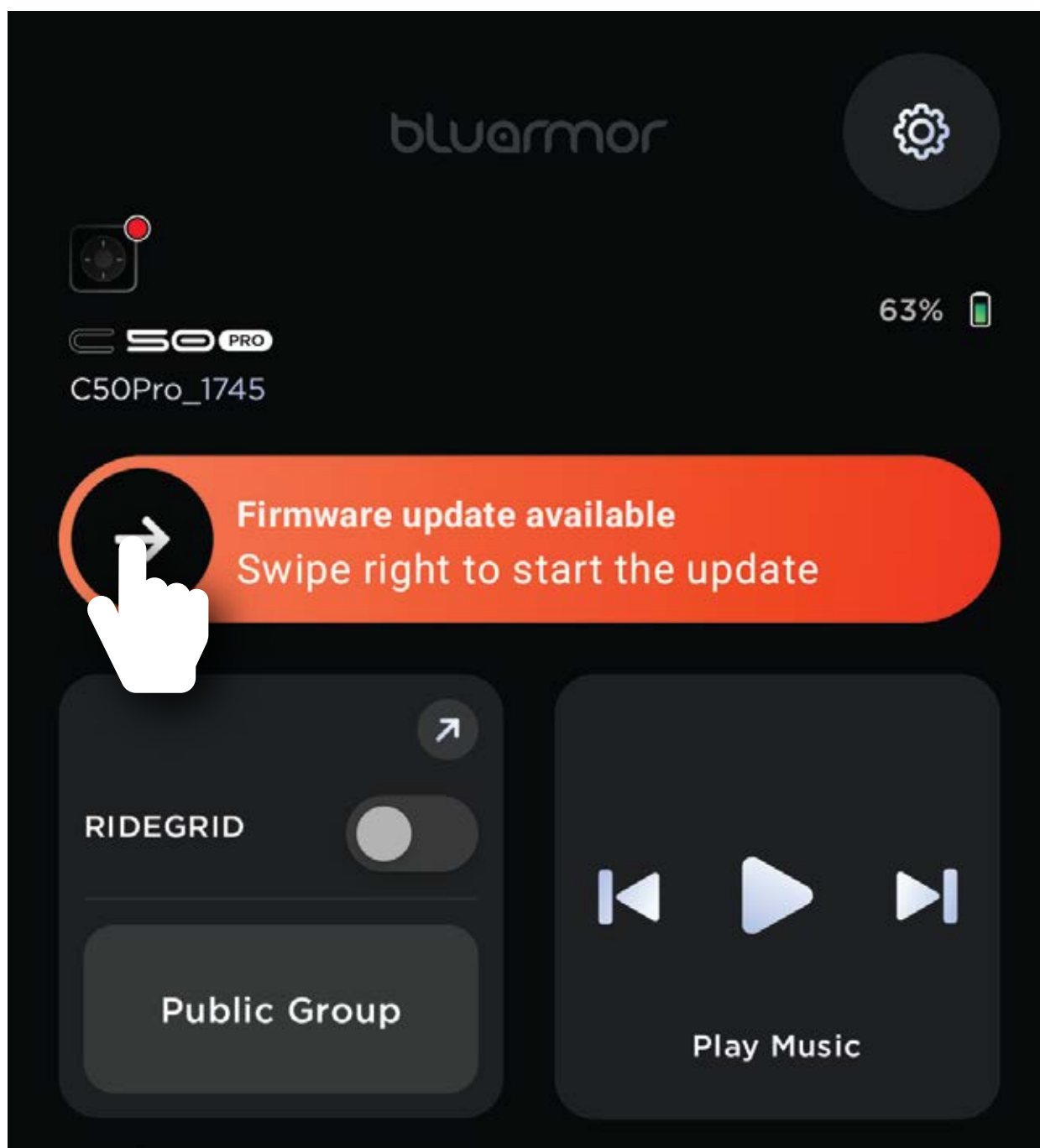

Swipe the slider and follow the steps, **ensure your device is at least 50% charged** before you start the update and **don't turn off the device during the process.**

The app will indicate the progress status.



**01** - PHONE CALLS

**02** - CALL VOLUME CONTROLS

**03** - AUTO ANSWER AND SETTINGS

**04** - SPEED DIAL

*a* - VIA 3 BUTTON MODULE

*b* - VIA TSTICK

**05** - MUSIC AND AUDIO

**06** - MUSIC VOLUME CONTROLS

**07** - NAVIGATION



# 01 PHONE CALLS

## RESPONDING TO INCOMING CALLS

### PHONE CALL CONTROLS

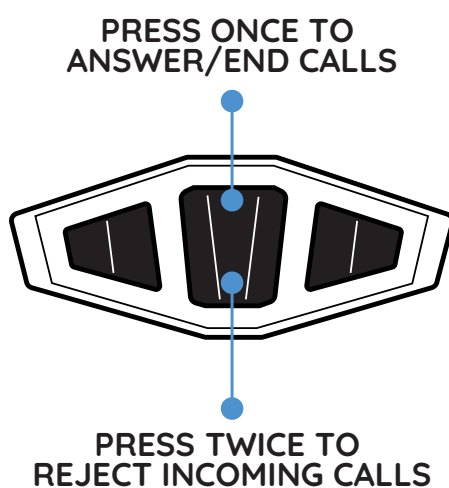

Making phone calls (setup assistant on your phone)  
While riding, please use the voice assistant on your phone to initiate phone calls.

## INVOKING THE VOICE ASSISTANT

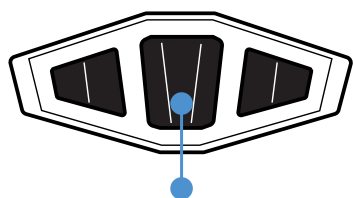

PRESS TWICE TO  
INVOKE VOICE ASSISTANT

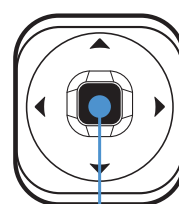

PRESS TWICE TO  
INVOKE VOICE ASSISTANT

To make phone calls while riding, please use the voice assistant (setup assistant on your phone) on your phone to initiate phone calls.

NOTE - YOU CANNOT INVOKE THE VOICE ASSISTANT WHILE ON AN ACTIVE CALL



02

## CALL VOLUME CONTROLS

### VOLUME CONTROLS WHILE ON A CALL

**+**  
PRESS ONCE TO  
INCREASE VOLUME BY  
ONE LEVEL

PRESS AND HOLD TO  
RAMP UP VOLUME

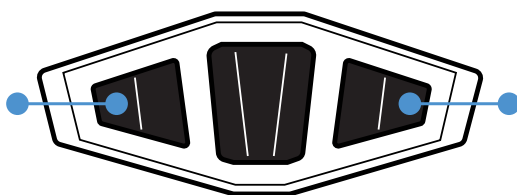

**-**  
PRESS ONCE TO  
DECREASE VOLUME BY  
ONE LEVEL

PRESS AND HOLD TO  
RAMP DOWN VOLUME

03

## AUTO ANSWER AND SETTINGS

You can configure your phone-call preferences through the app.

An array of auto-accept/auto-reject options are available - these can be set as desired.

### Phone Call preferences

Phone call auto answer/reject

- Answer manually
- Auto answer all
- Auto reject all
- Auto answer known
- Auto reject unknown
- Auto answer known and reject unknown



## 04 SPEED DIAL

For Speed dial to work you have to add the desired contacts through the app settings.

**Speed dial** can be **initiated** using the **3 button module** and the **Tstick**.

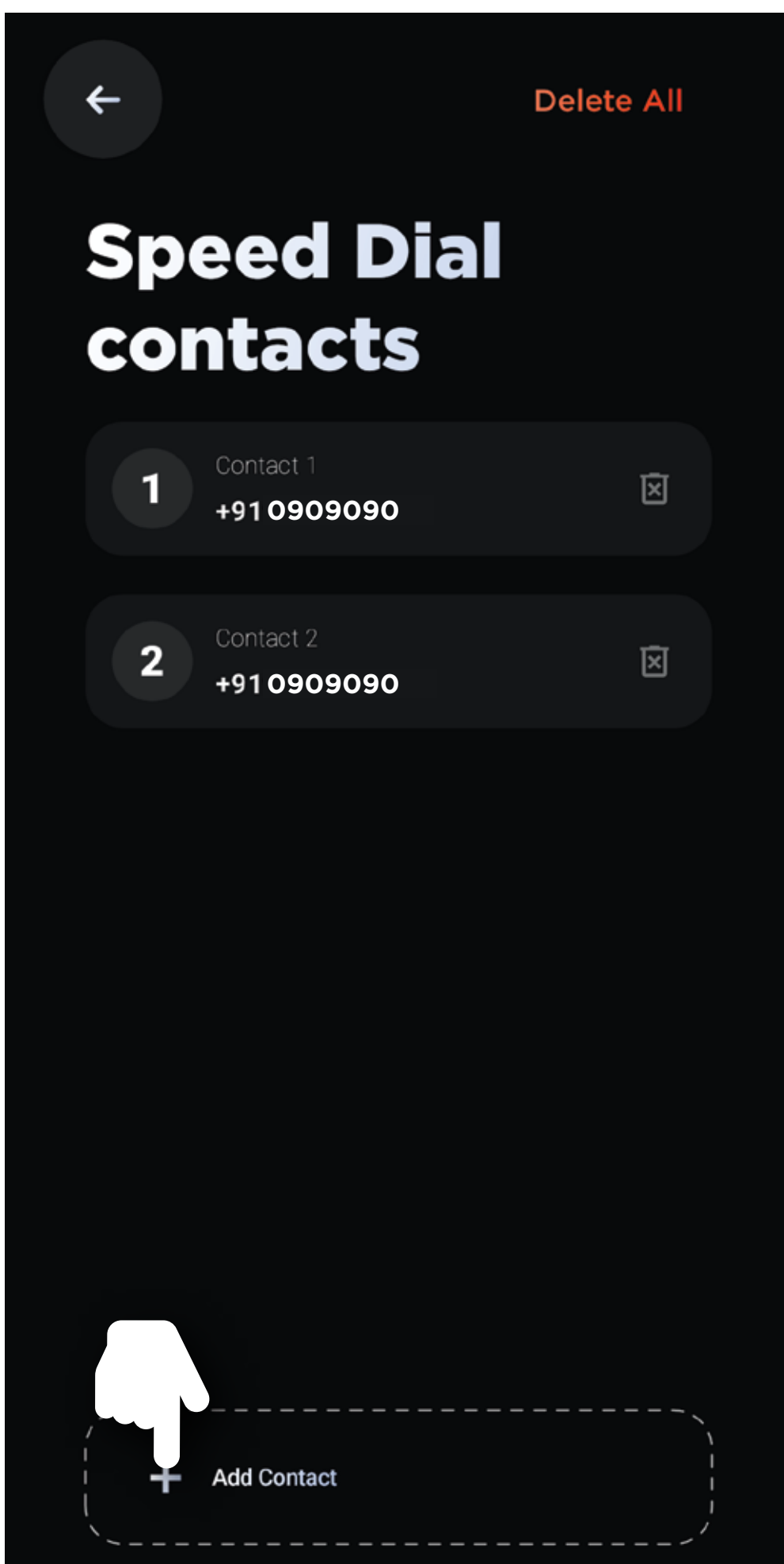

NOTE - A MAXIMUM OF 5 CONTACTS CAN BE ADDED TO YOUR SPEED DIAL LIST



## ACCESSING SPEED DIAL

### a - VIA 3 BUTTON MODULE

#### SPEED DIAL CONTROLS

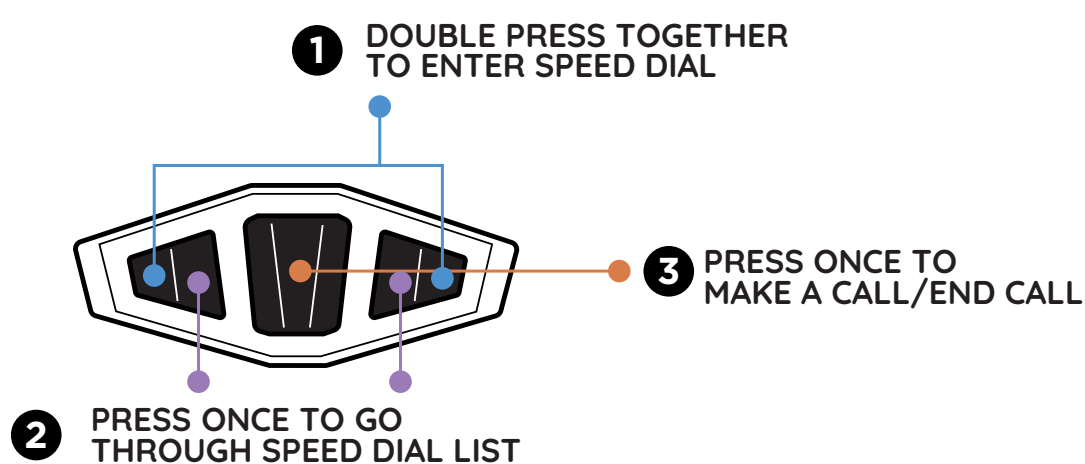

### b - VIA TSTICK

- Push the joystick to the right and then push it down to speed dial
- Now you can push down or up on the joystick to go through the speed dial list.
- Once you hear the number assigned to a contact through the headset  
Eg: Contact one
- Push down on the centre button to start a call.
- Once you are done with the call push the centre button again to end the call

#### SPEED DIAL CONTROLS

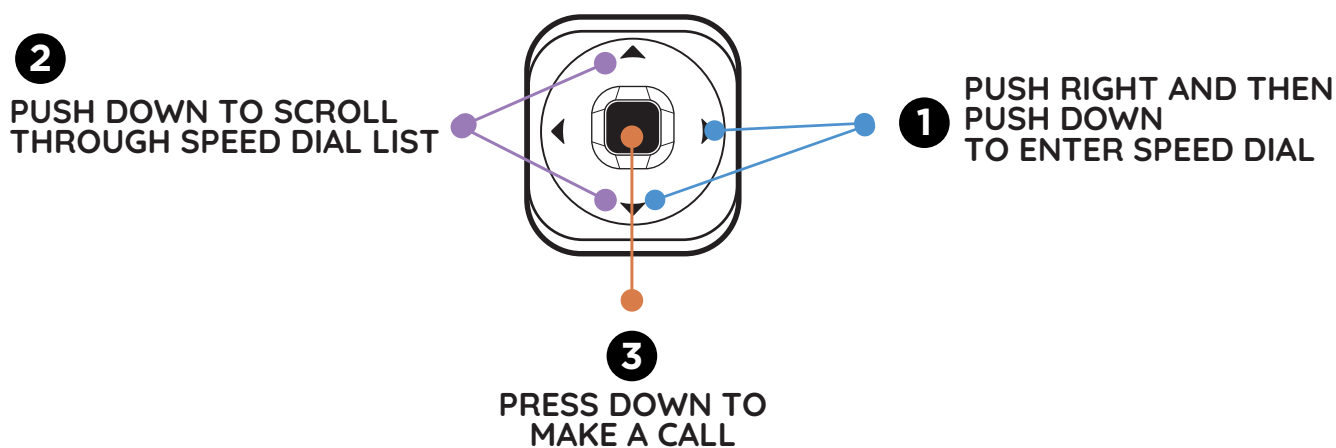



## 05 MUSIC AND AUDIO

Choose a music/audiobook/podcast app of your choice and launch it on your phone.

You can **control** any of your **favourite music** or **audio apps** using the **3 button module, Tstick** or from **the app**.

### a - VIA 3 BUTTON MODULE

#### MUSIC CONTROLS

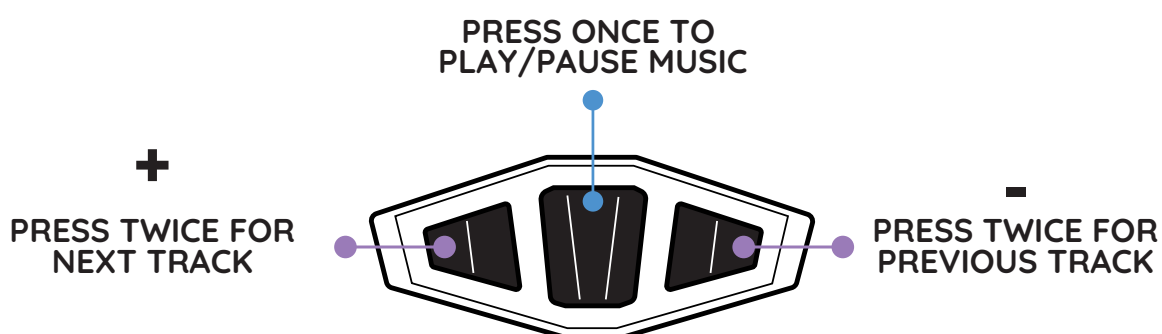

### b - VIA TSTICK

#### MUSIC CONTROLS

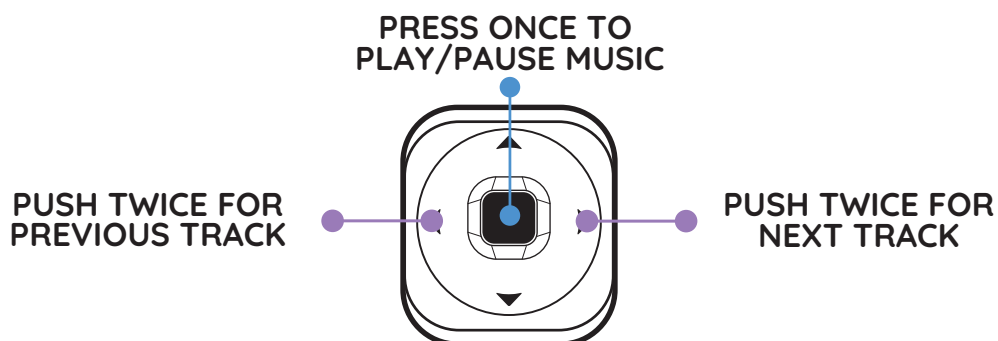





## c - USING THE APP

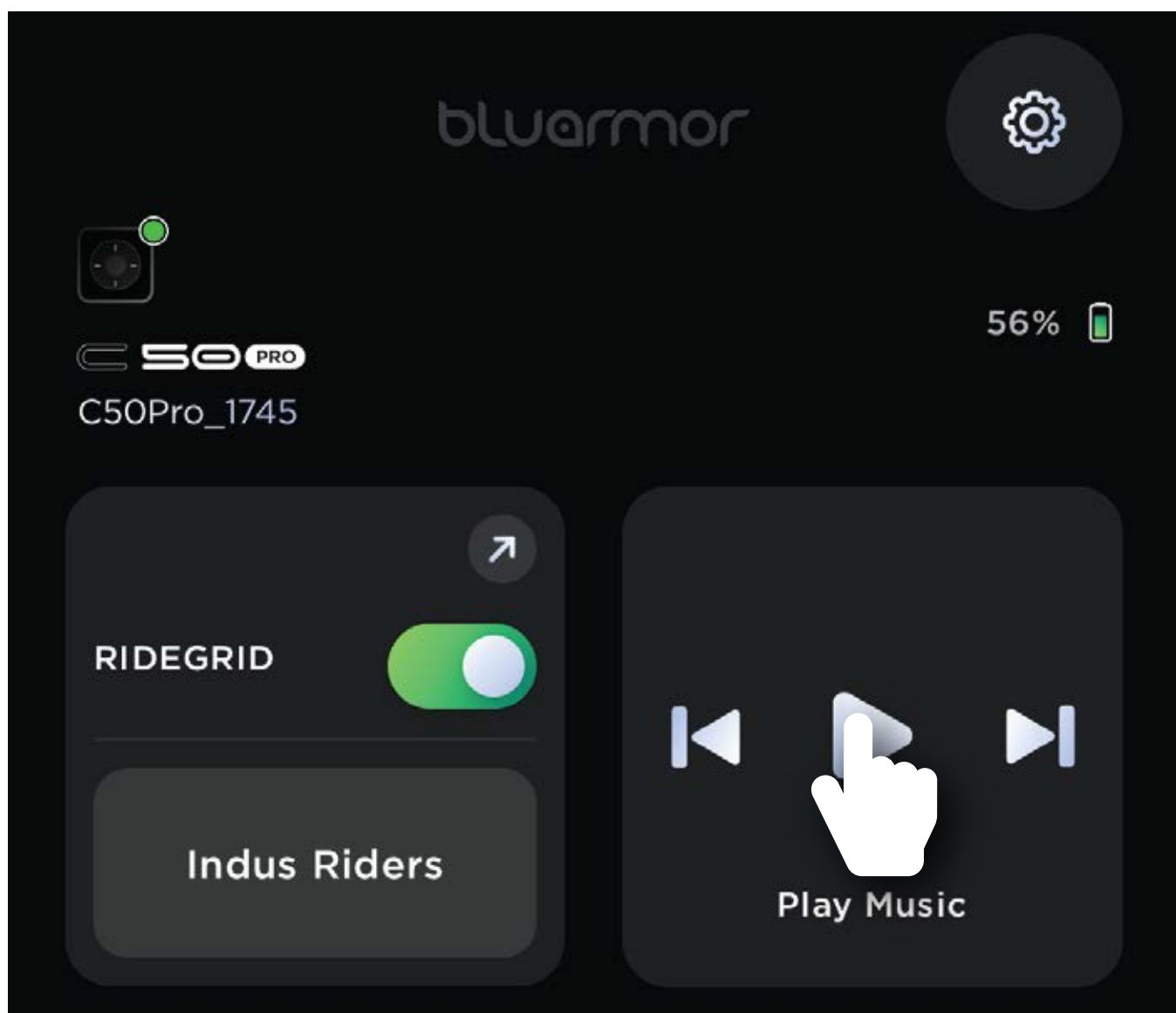

The home page features a tile for your music playback controls



06

## MUSIC VOLUME CONTROLS

There are **15 possible volume levels** between the **minimum** and **maximum**.

You can **control** the volume of the music using the **3 button module, Tstick** or **the app**.

### a - VIA 3 BUTTON MODULE

#### MUSIC VOLUME CONTROLS

**+**  
PRESS ONCE TO  
INCREASE VOLUME BY  
ONE LEVEL

PRESS AND HOLD TO  
RAMP UP VOLUME

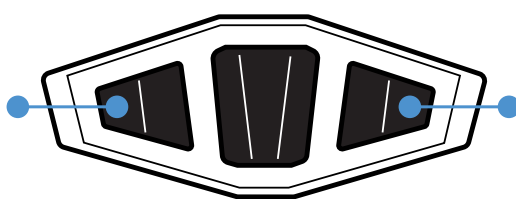

**-**  
PRESS ONCE TO  
DECREASE VOLUME BY  
ONE LEVEL

PRESS AND HOLD TO  
RAMP DOWN VOLUME

### b - VIA TSTICK

#### MUSIC VOLUME CONTROLS

PRESS ONCE TO  
INCREASE VOLUME BY  
ONE LEVEL

PRESS AND HOLD TO  
RAMP UP VOLUME

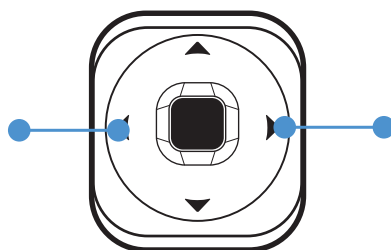

PRESS ONCE TO  
DECREASE VOLUME BY  
ONE LEVEL

PRESS AND HOLD TO  
RAMP DOWN VOLUME



## C - USING THE APP

Use the **volume dial** in the **app** to **increase** or **decrease** the volume.

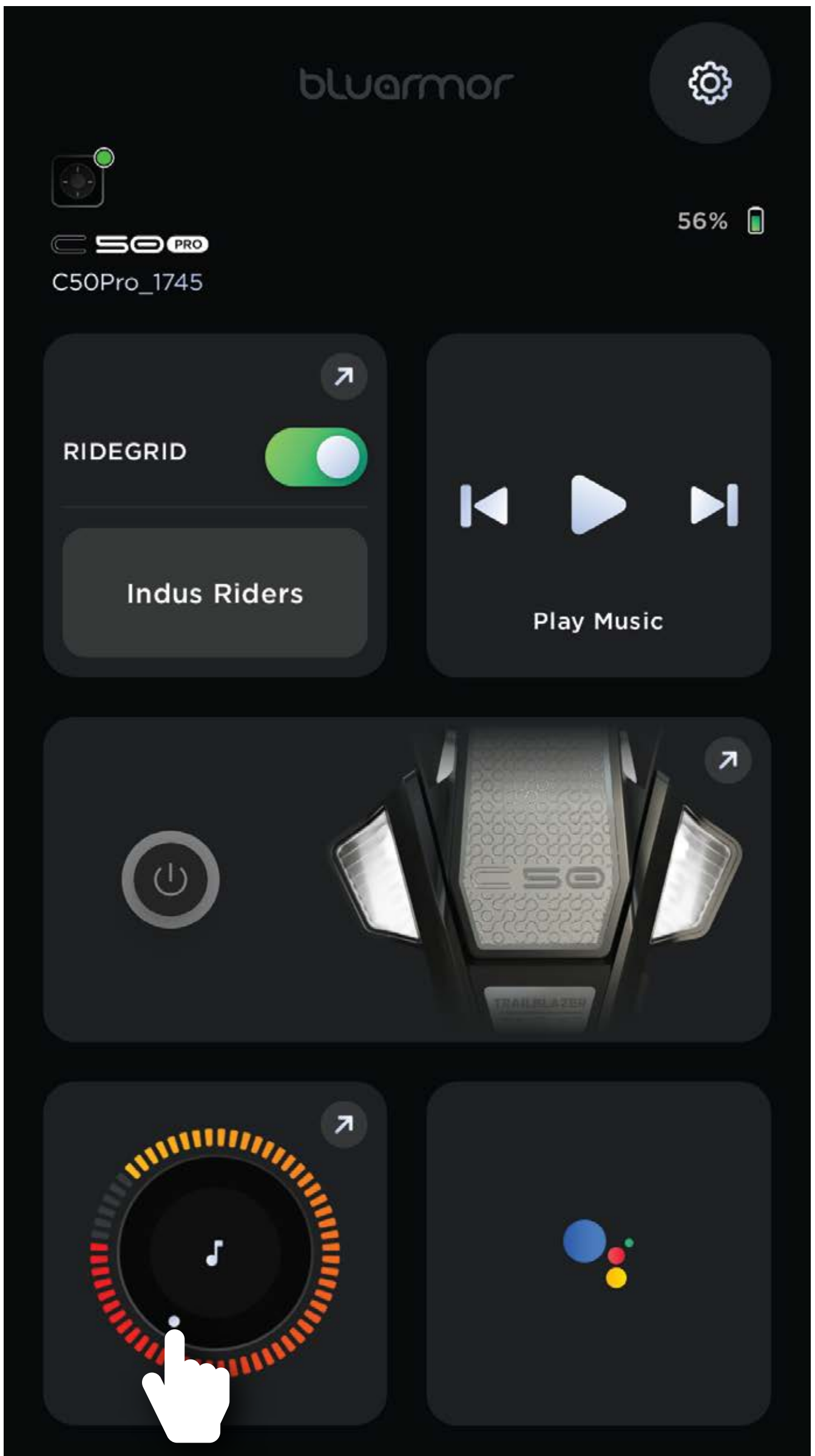



## 07 NAVIGATION

### NAVIGATION INSTRUCTIONS OVER VOICE

Navigation instructions from your mapping/navigation app will be announced over the headset

### USE VOICE ASSISTANT FOR THESE CONTROLS

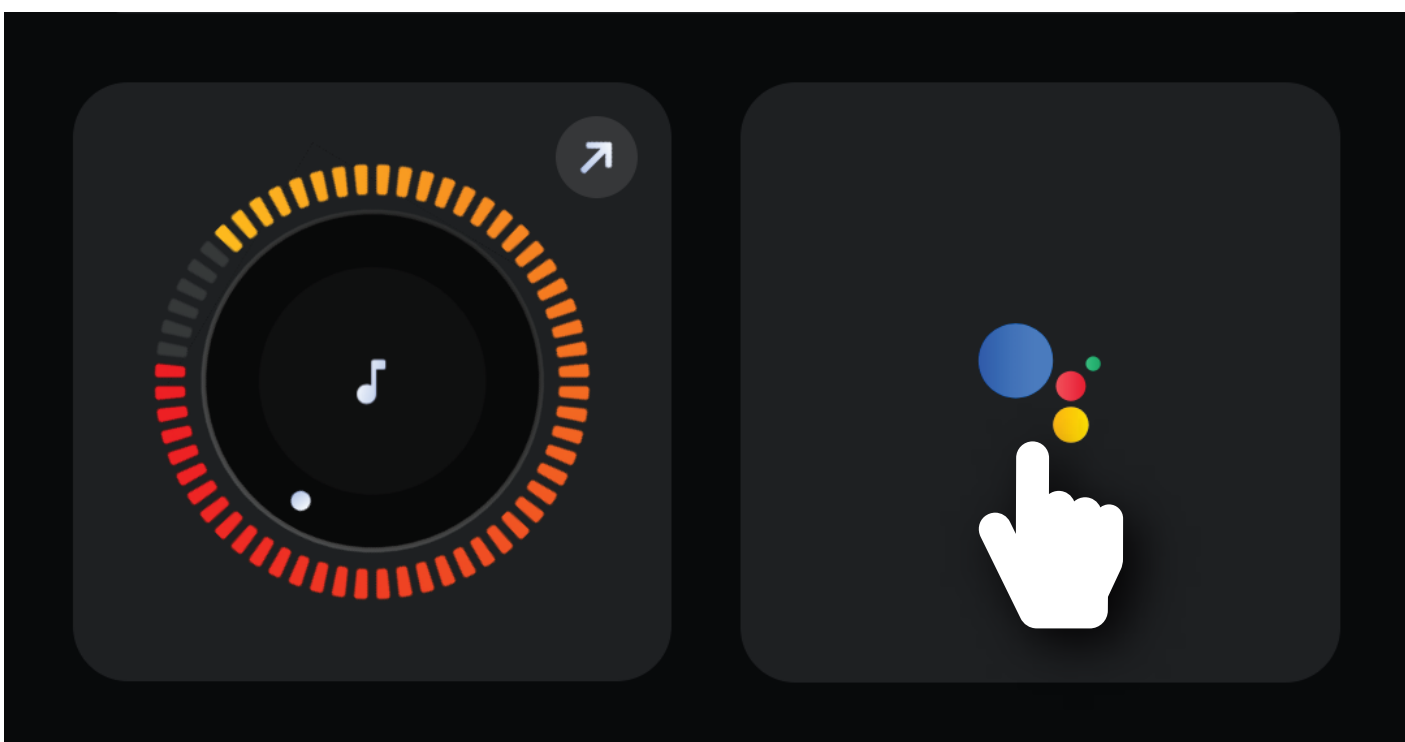

### INVOKING THE VOICE ASSISTANT





**01** - OVERVIEW

**02** - FUNCTIONS

*a* - TURNING ON/OFF

*b* - PRESETS

*c* - CUSTOMISING YOUR  
PRESET



## 01 OVERVIEW

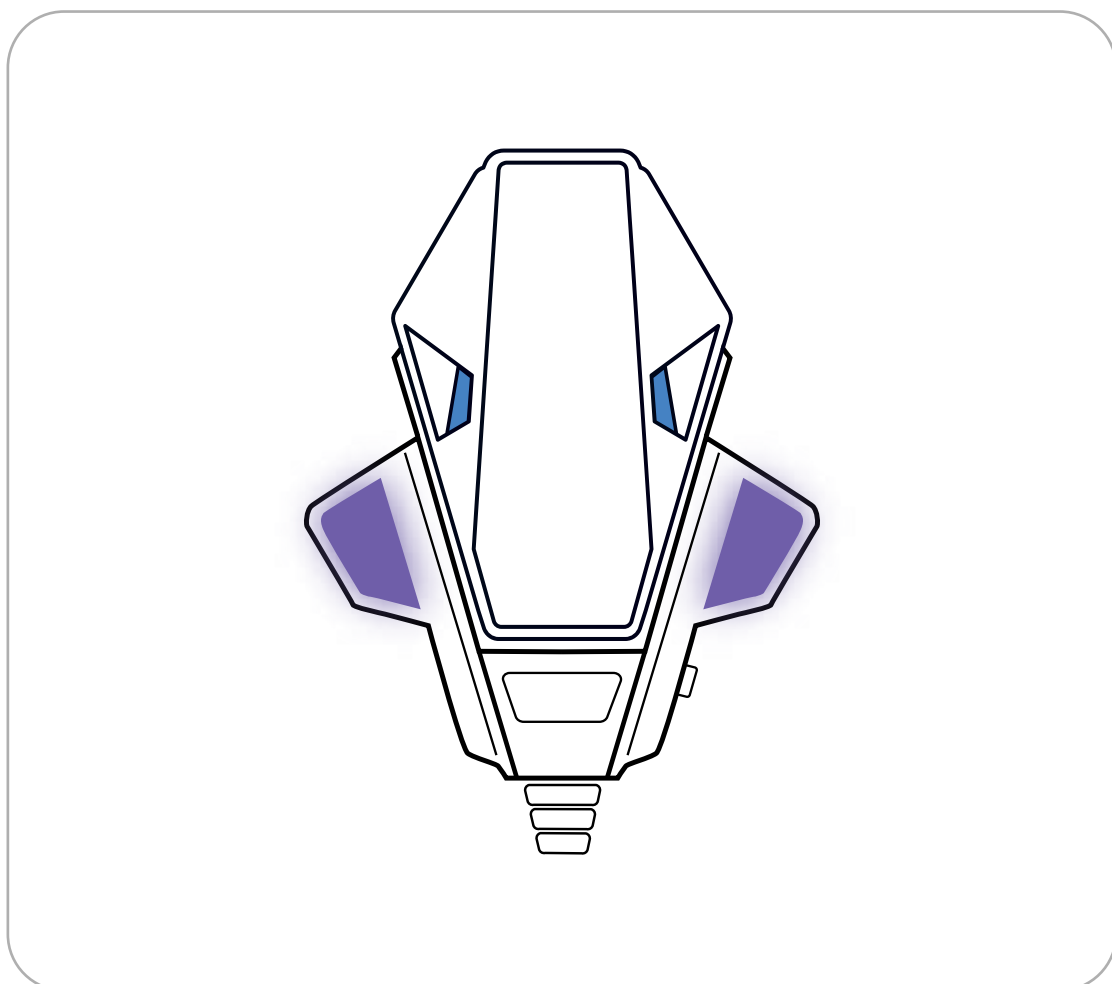

**RIDEAURA™** is the latest innovation at BluArmor and is part of the MagDock. This is a lighting feature that allows both personalisation and visibility of the rider on the road using the LED arrays that are built into the MagDock.





## 02 FUNCTIONS

To **control** the **RIDEAURA™**, you need to connect to the **BluArmor app**.

Once connected you'll see the RIDEAURA™ setting in the app dashboard.

NOTE - YOU CAN ENABLE THE RIDEAURA'S HAZARD MODE WITHOUT CONNECTING TO THE APP, BY USING THE 3 BUTTON MODULE. BUT YOU CANNOT SWITCH MODES OR CUSTOMIZE PRESETS.

### a - TURNING ON/OFF

You can turn the RIDEAURA™ on or off in two ways.

The quickest method is using the dedicated on/off button located on the RIDEAURA™ tab on the app's home screen—simply tap it to toggle the feature.

Alternatively, for more control, tap on the RIDEAURA™ tab to enter its detailed settings, where you'll find an AURA toggle switch that allows you to turn it on or off as needed. This gives you the flexibility to manage RIDEAURA™ either instantly from the home screen or through the settings for a more customized experience.

### SWITCH ON RIDEAURA™ USING THE 3 BUTTON MODULE

**RIDEAURA**  
(ON/OFF)

PRESS TWICE  
+  
PRESS AND HOLD

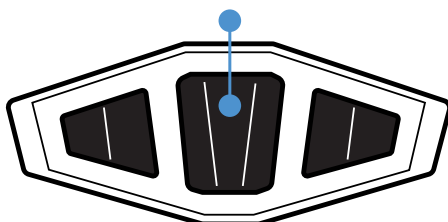



## b - PRESETS

Preset page of the RIDEAURA™ includes two lighting modes,

### **HAZARD MODE & BRAKE MODE.**

You can turn on/off either of the modes or can keep both modes on or off.

#### **WHAT IS HAZARD MODE?**

Hazard Mode is designed for situations where visibility is significantly reduced, ensuring that you remain noticeable to your co-riders and other vehicles around you. This mode is particularly useful in conditions such as heavy fog, rain, snow, or poorly lit roads. When activated, Hazard Mode enhances your presence by flashing light to alert others about your position. This added visibility helps prevent accidents, keeps you safer in unpredictable environments, and ensures that fellow riders or drivers can detect your presence from a distance.

#### **WHAT IS BRAKE MODE?**

Brake Mode is a safety feature designed to enhance visibility and alert others when you slow down suddenly. The main unit detects rapid deceleration and activates the RIDEAURA™ in a bright red light, signaling to co-riders and vehicles behind you that you are braking. This immediate visual cue helps prevent rear-end collisions, especially in high-speed or group riding scenarios.





## C - PRESET CUSTOMISING

You can fully customize the RIDEAURA™ by choosing any color and light pattern to match your preference.

Simply tap the Create button to access the color wheel and select your desired color. Next, name your preset and choose from four available light patterns: Blink, Breathe, Ramp, and Strobe. Additionally, you can adjust the pattern speed, ranging from 1x to 4x, for a subtle or more dynamic riding experience.

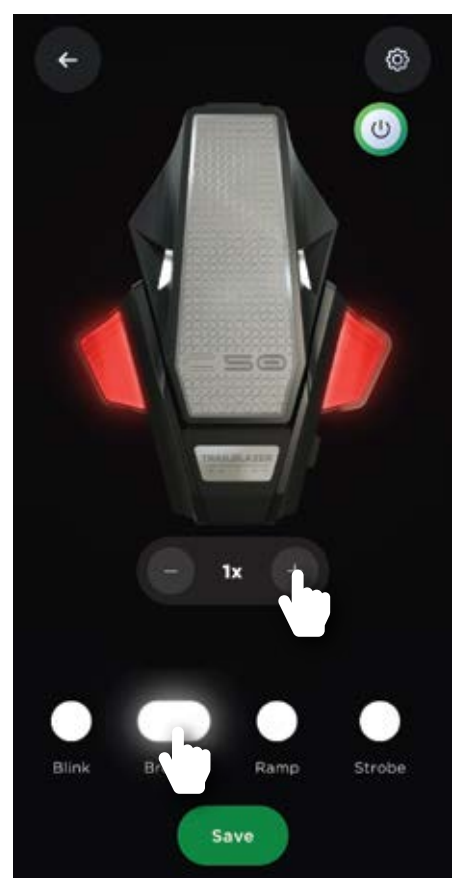
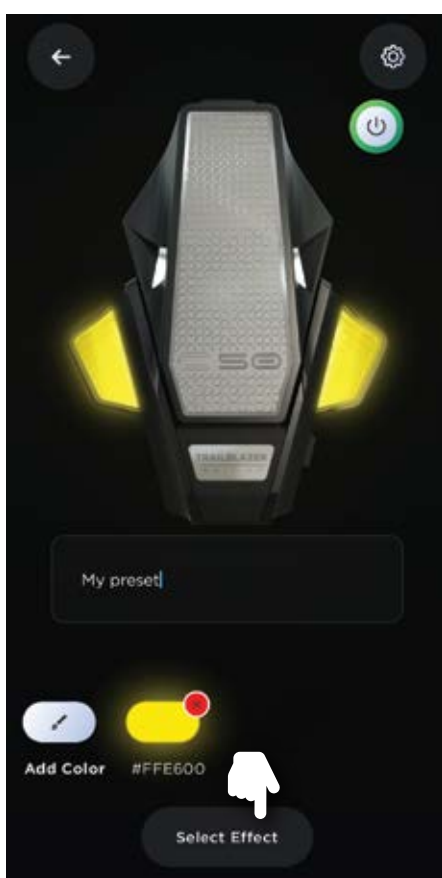
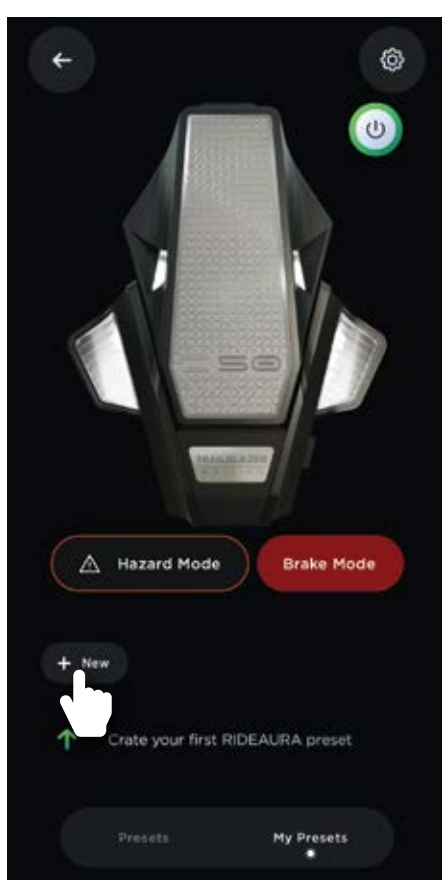
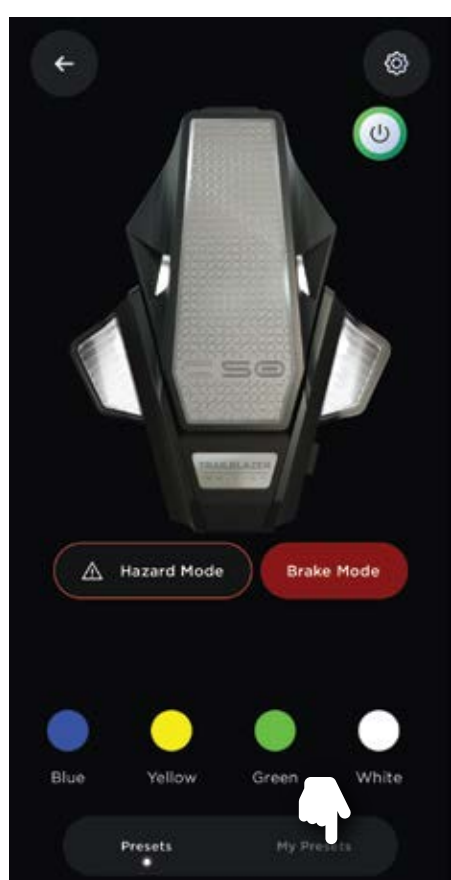

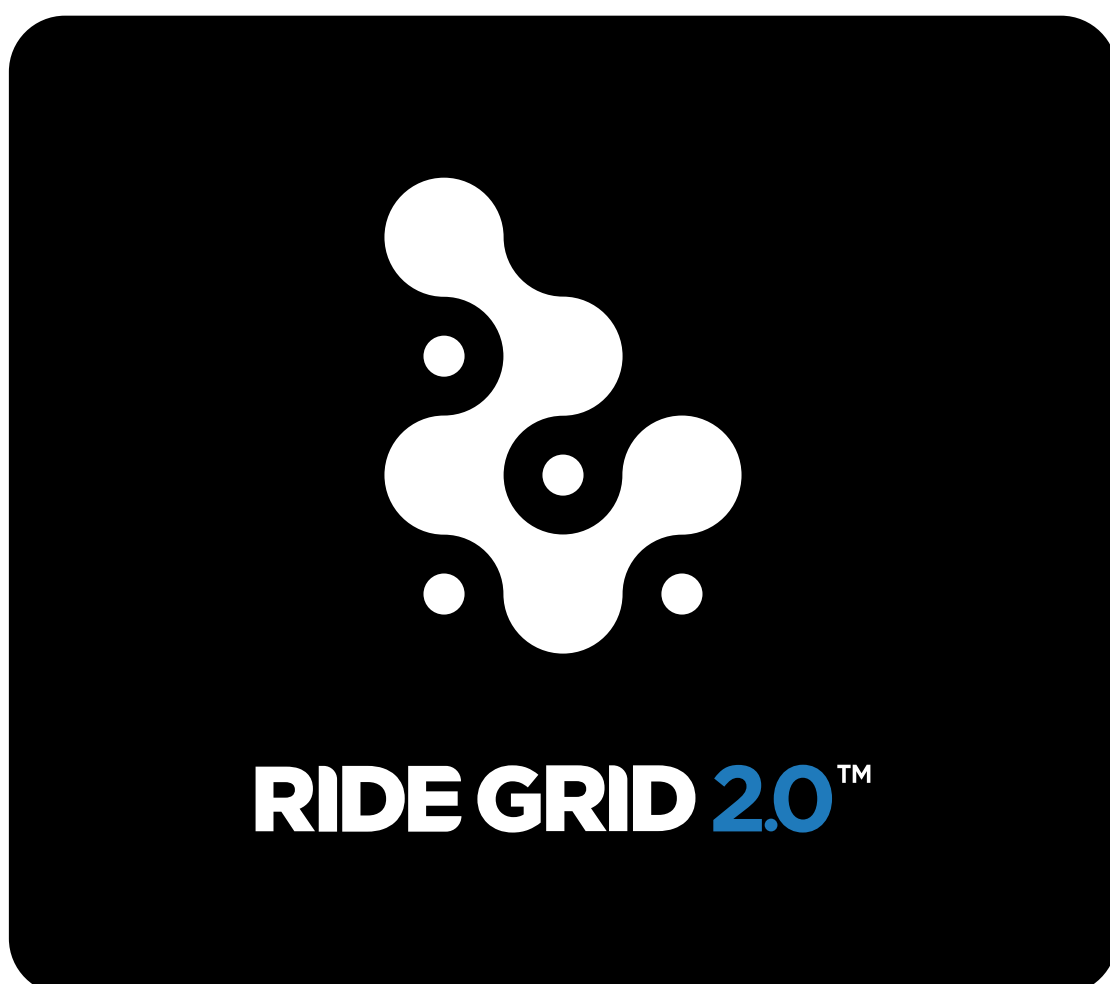

**01** - WHAT IS RIDEGRID 2.0™

**02** - OVERVIEW

**03** - CONNECTING THE RIDEGRID

*a* - VIA 3 BUTTON MODULE

*b* - VIA TSTICK

**04** - GROUPS AND GROUP CREATION

*a* - PUBLIC GROUPS

*b* - PRIVATE GROUPS

**05** - UNIVERSAL INTERCOM

*a* - VIA 3 BUTTON MODULE

*b* - USING THE APP

**06** - MERGING ACTIVE PHONE CALLS

**07** - eRIDEGRID



01

## WHAT IS RIDEGRID 2.0™



**RIDE GRID 2.0™**  
ADVANCED MESH INTERCOM

**RIDEGRID 2.0™** is an intercom mesh technology that uses its advanced algorithm to connect multiple C50 devices (up-to 20 for optimal performance) together to form a flexible intercom network that allows riders to freely go out and come back into the large group call.

This self healing and clustering quality of RIDEGRID 2.0™ makes it extremely user-friendly and easy to use in the real world situations that you ride in.

**RIDEGRID 2.0™ range between 2 riders is 1.2 Km.**

(2 Users maintaining **Line Of Sight (LOS)** on an open highway)



## 02 OVERVIEW

Out of the box, the devices are set to RIDEGRID 2.0™ public mode, which allows your co-riders to join automatically.

It is also possible to create private groups using the app.

Use the app to create private groups and add members by using the invite QR code at the end of the process.

Any member of the riding group can invite new members in.

A member can freely choose to leave the group.

### **Clustering**

While on a RIDEGRID 2.0™ call, users who are within range of each other but collectively out of range from other riders in the same group will be able to talk to each other.

### **Self-healing**

Riders automatically rejoin the call as they come back into range.



03

## CONNECTING THE RIDEGRID

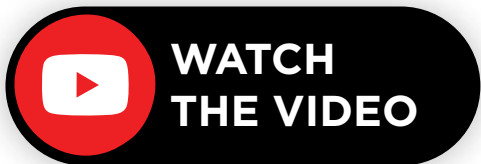

### a - VIA 3 BUTTON MODULE

**RIDEGRID 2.0™**  
(ON/OFF)

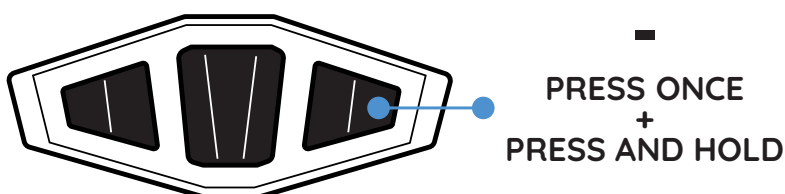

Repeat the same steps on your co-rider's device.

The LEDs on the devices will flash green and then switch to green breathing once the connection is established. Once activated, RIDEGRID is ready for use.

NOTE - C50 UNITS DO NOT NEED TO BE CONNECTED TO THE PHONE FOR RIDEGRID TO WORK

### b - VIA TSTICK

**RIDEGRID 2.0™**  
(ON/OFF)

PUSH UP TWICE  
+  
PUSH AND HOLD FOR 1 SEC

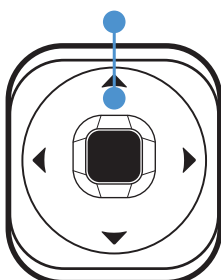



04

## GROUP & GROUP CREATION

There are two categories of groups in the RIDEGRID 2.0™ menu.

### PUBLIC GROUP & PRIVATE GROUP

#### a - PUBLIC GROUPS

Make sure the RIDEGRID is on first.  
Then expand the Group and click on Group icon.  
By default you will be connected to the 'PUBLIC GROUP'

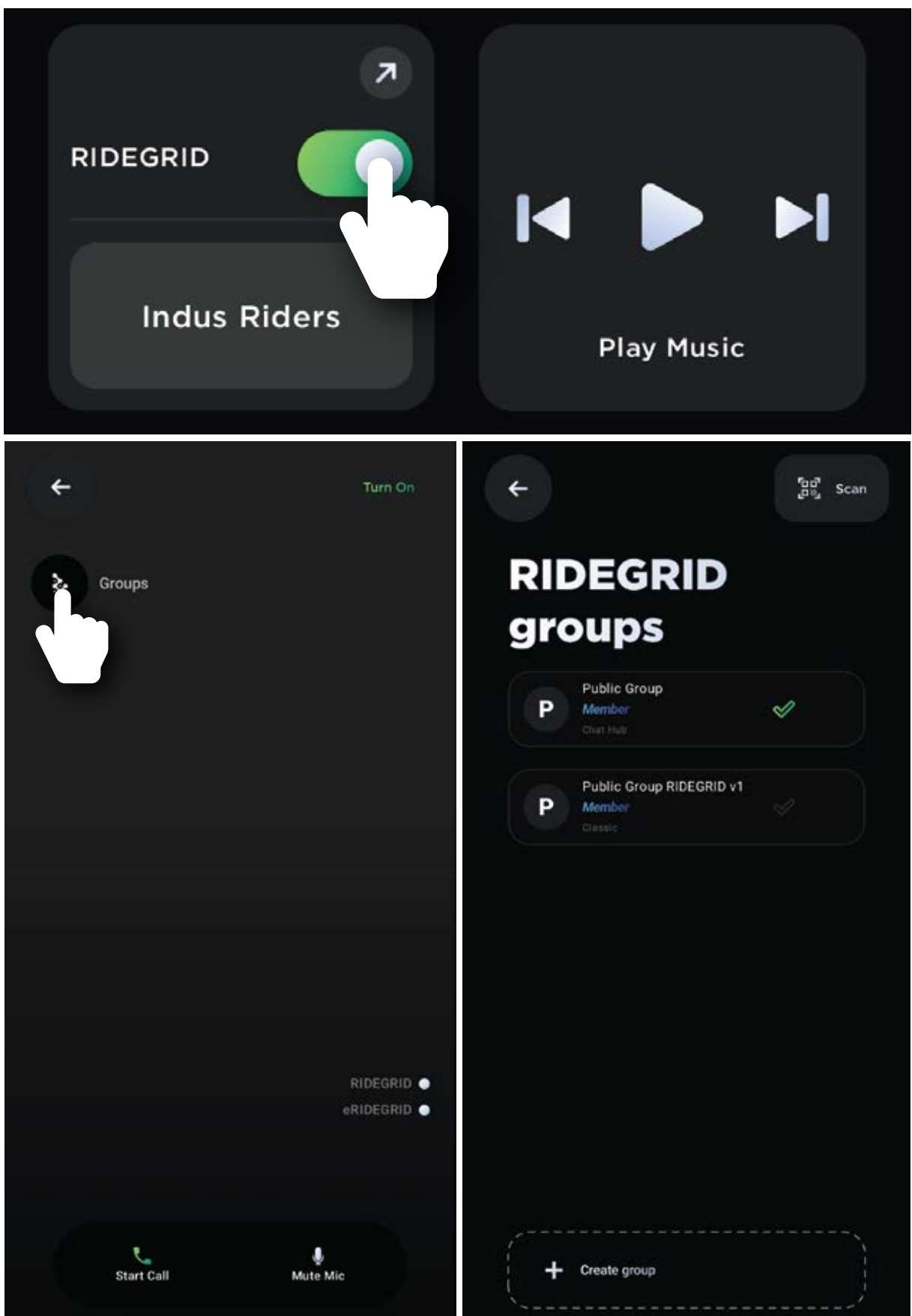



How to connect C30 devices that use RIDEGRID V1 (Classic) with C50 devices?

- Open the BluArmor app and navigate to the group creation settings.
- Tap on the 'Public Group RIDEGRID V1' and add members to the group.

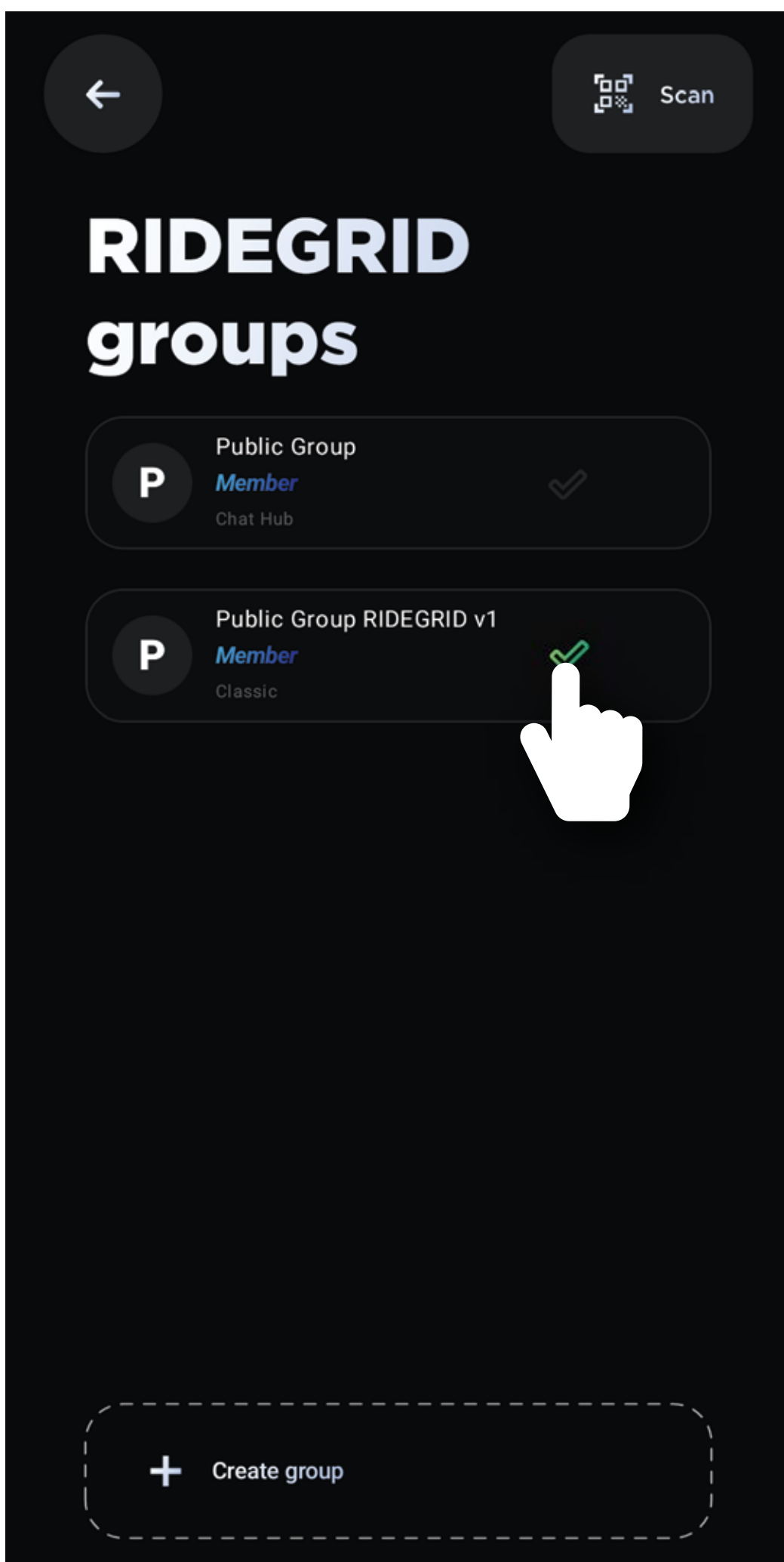



## b - PRIVATE GROUPS

NOTE - USE THE APP TO CREATE AND MANAGE RIDEGRID 2.0™ PRIVATE GROUPS

- Open the BluArmor app and expand the RIDEGRID 2.0™ tab
- Click on the Groups button.
- Click on Create group tab at the bottom of the screen
- Name your group and select the type of group you want out of the four group

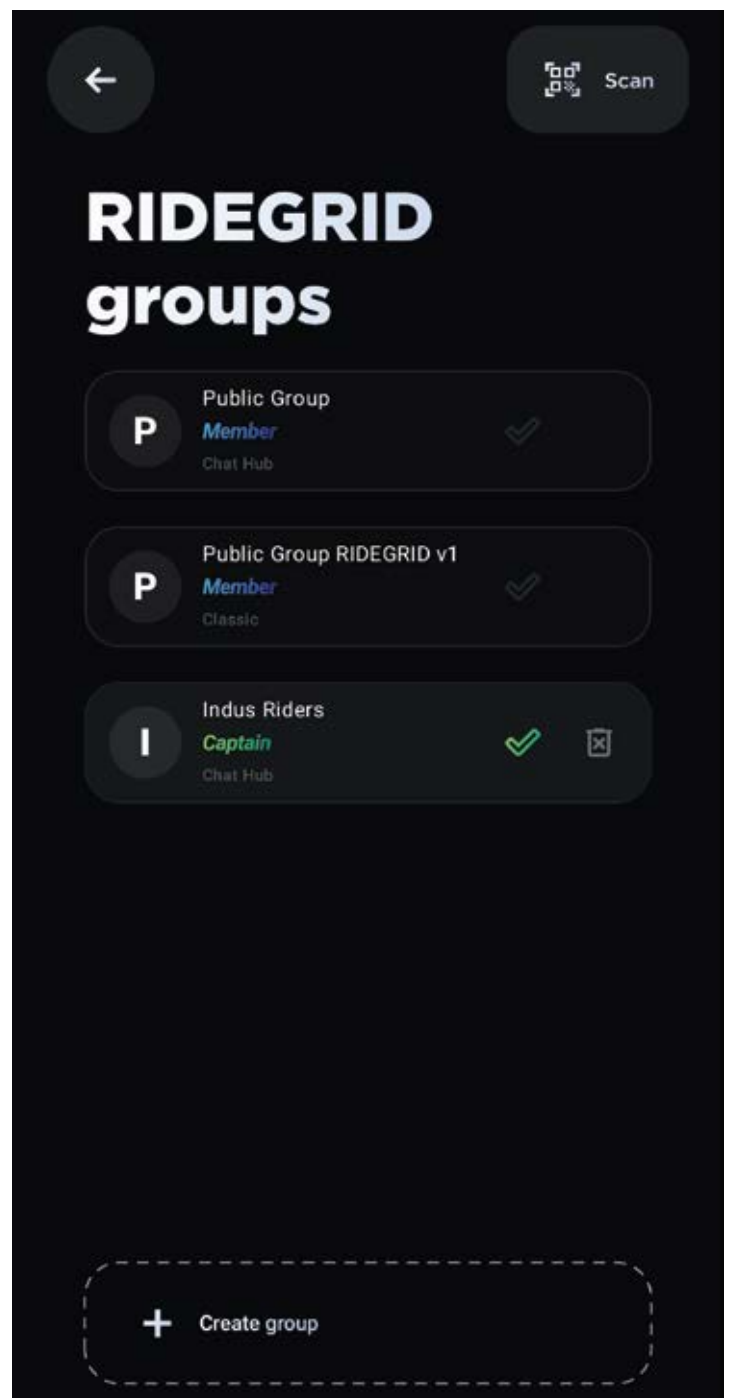
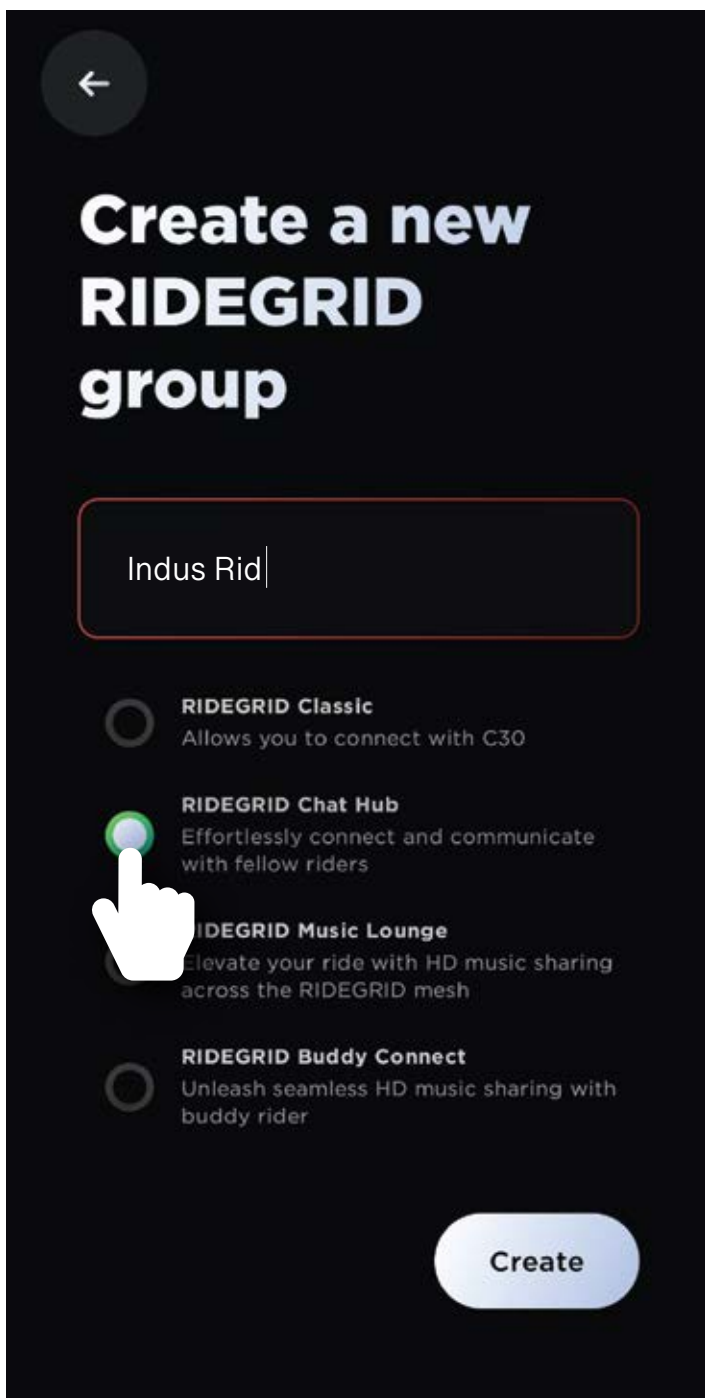

- **RIDEGRID Classic**  
Lets you connect with C30 devices
- **RIDEGRID Chat Hub**  
Communicate with your co-riders
- **RIDEGRID Music Lounge**  
SD music sharing across the RIDEGRID Mesh
- **RIDEGRID Buddy Connect**  
HD music sharing only with your buddy rider.



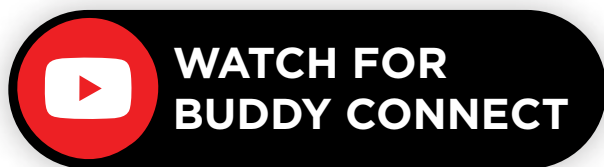
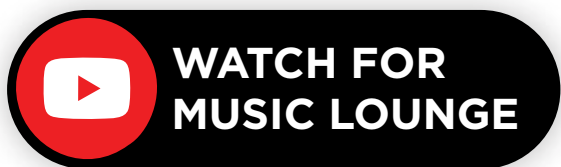

Now, let's see how to **share music** in **Music Lounge** and **Buddy Connect** groups.

## a - VIA 3 BUTTON MODULE

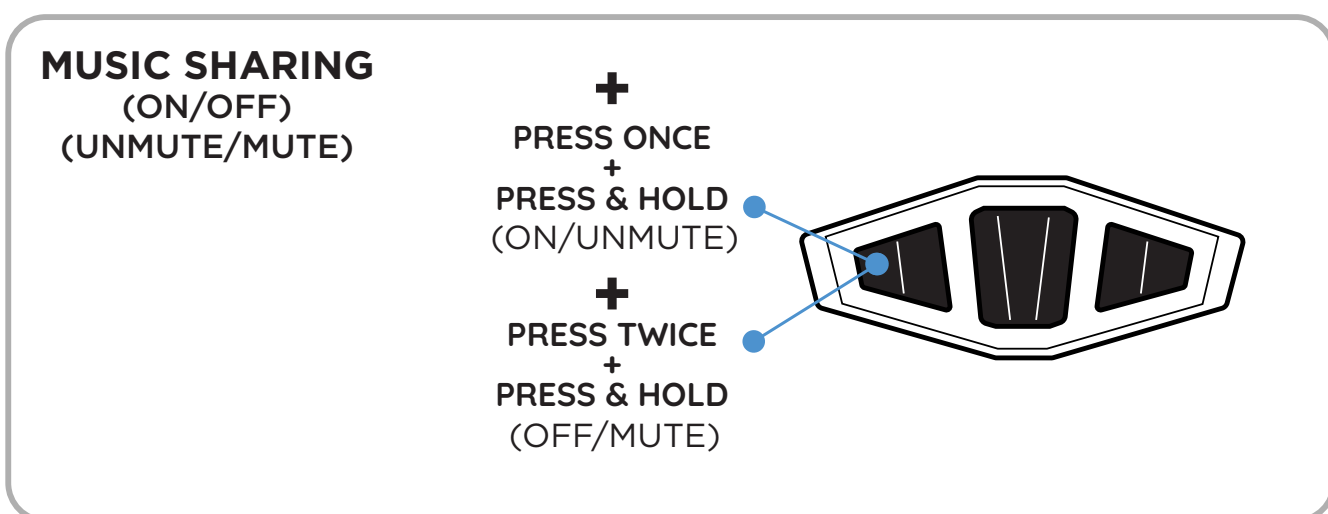

## b - VIA TSTICK

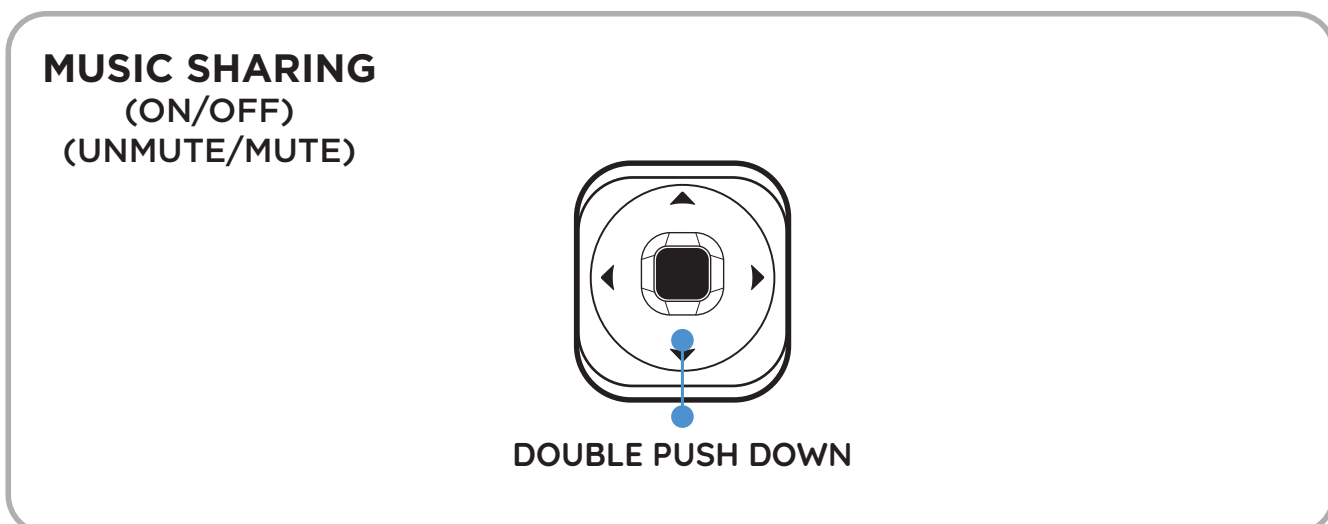

## c - USING THE APP

Use the button on the app, shown below to control music sharing a PTT

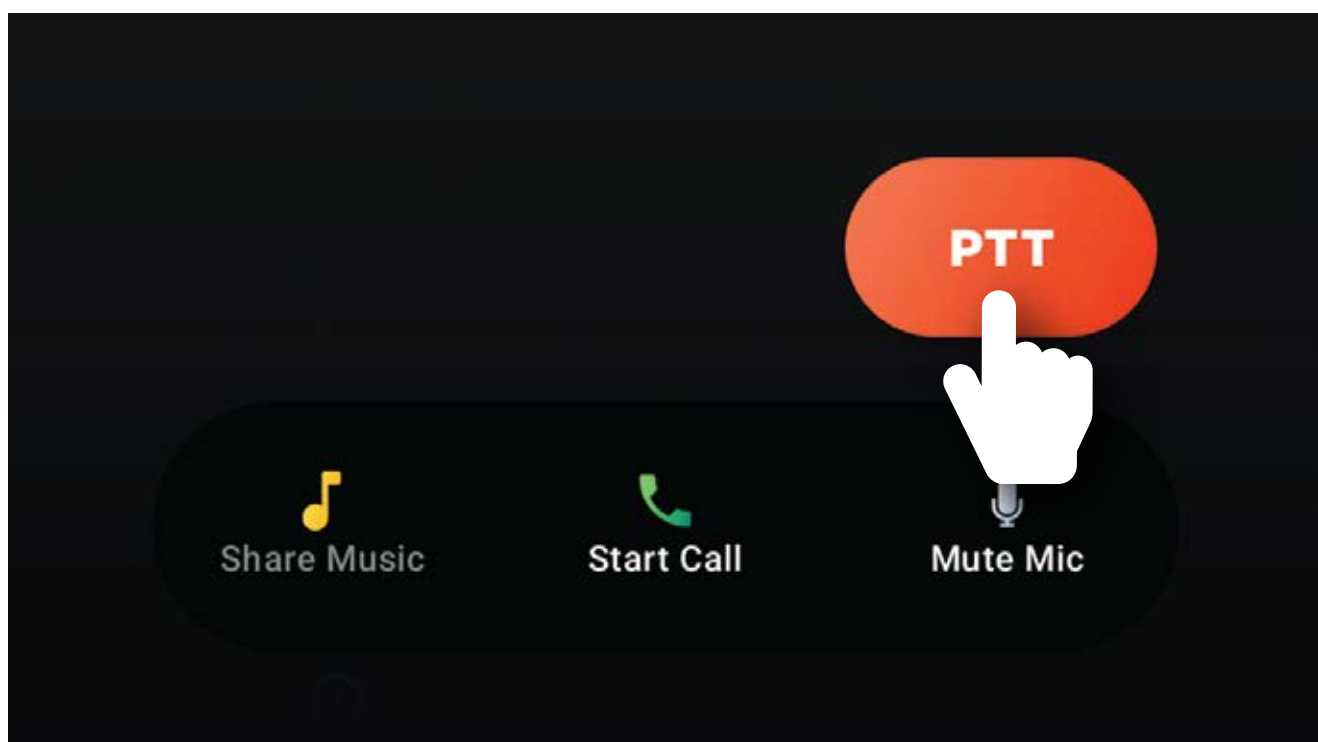



There will be a **Captain**, a **Sweepers**, and **Members**, when you create a **RIDEGRID Chat Hub Group**

The **Captain** can **talk to** the **Sweepers**, **discreetly** using **PTT Hotline**. Hotline calls are conversations between the Captain and Sweepers.

#### HOTLINE

PUSH UP  
&  
KEEP HOLDING

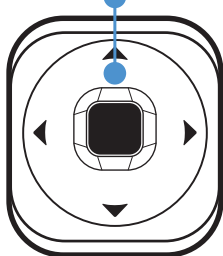

If the **Captain** wishes to **broadcast** to the entire group, he can use **Captain announcement mode**.

#### CAPTAIN ANNOUNCEMENT

PUSH DOWN  
&  
KEEP HOLDING

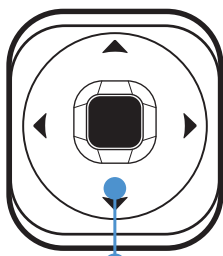

While in the **RIDEGRID Music Lounge**, you cannot talk to your members unless you use the **PTT** action using the **TStick**

#### PTT WHILE MUSIC SHARING

PUSH UP  
&  
KEEP HOLDING

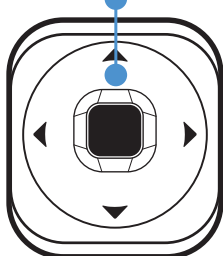

NOTE - USER WHO IS "STREAMING" HAS TO BE SELECTED USING THE APP.



05

## UNIVERSAL INTERCOM

NOTE - UNIVERSAL INTERCOM IS A PART OF PORTWEAVE™ WHICH WILL BE MENTIONED LATER IN THIS USER MANUAL

**Universal Intercom** is the ability to **connect** with **non C50 devices** that are **generic bluetooth headsets**.

You can **activate Universal Intercom** using the **3 Button Module** and **the App**.

### a - VIA 3 BUTTON MODULE

**UNIVERSAL INTERCOM**  
(ENTER/EXIT)

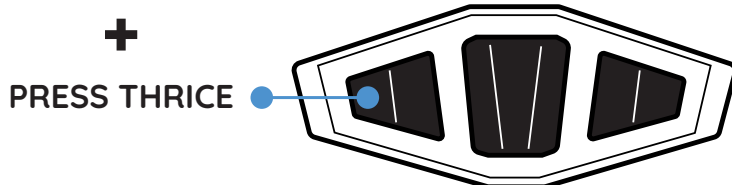

NOTE - ENSURE THAT THE ACTION IS PERFORMED WHEN NO OTHER SECONDARY DEVICE IS CONNECTED. ADDITIONALLY, NOTE THAT IF THE UNIVERSAL INTERCOM IS USED, NO OTHER SECONDARY DEVICE CAN BE CONNECTED, AS THE UNIVERSAL INTERCOM FUNCTIONS AS A SECONDARY DEVICE.

### Universal intercom: Not available

A device is already paired as the second connection. To connect to Universal Intercom, please disconnect the active second device first.

Ok



## b - USING THE APP

- Click on settings icon
- Click on Universal Intercom tab
- Now you can add a non C50 device

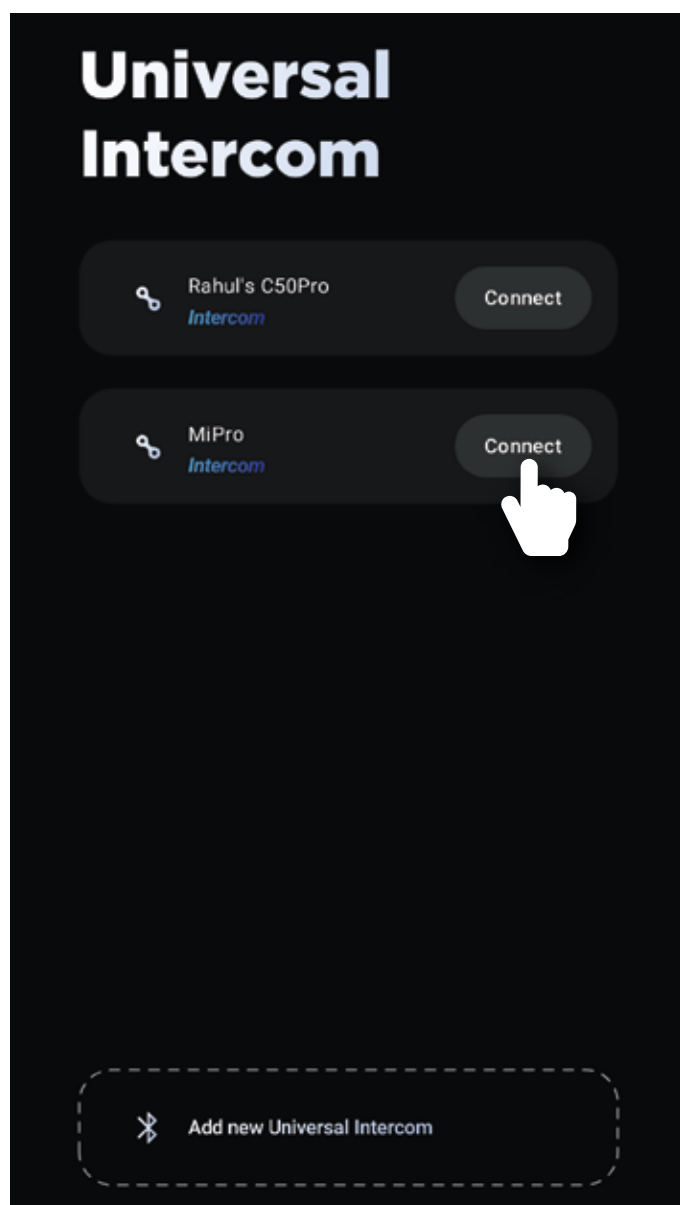
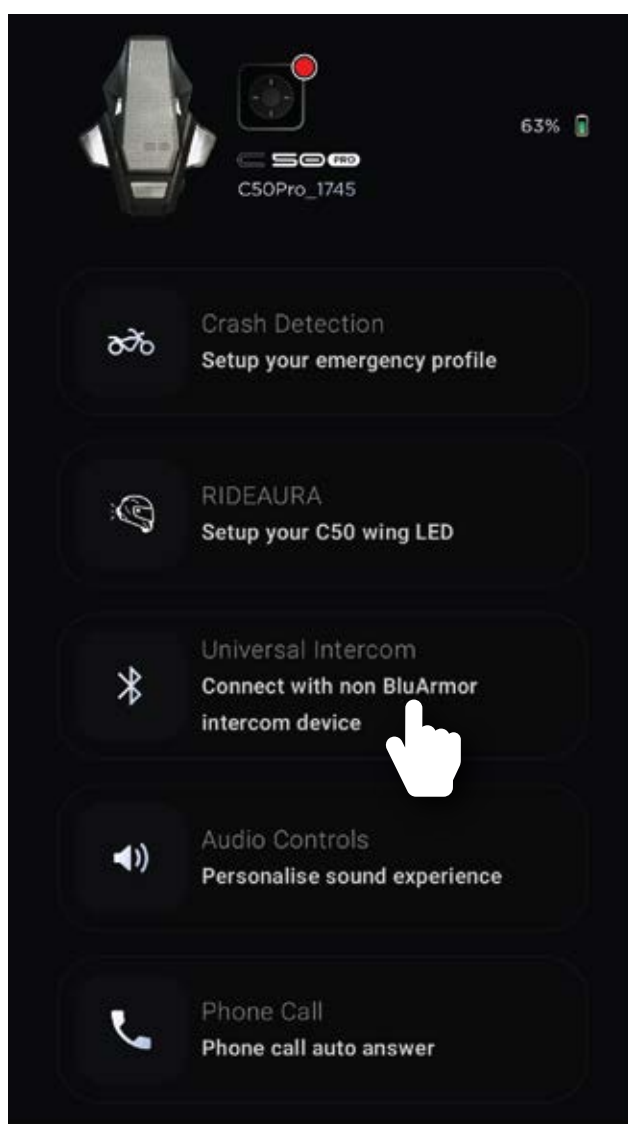



06

## MERGING ACTIVE PHONE CALLS

### MERGING ACTIVE PHONE CALLS WITH ONGOING RIDEGRID 2.0™ CALL

While on a RIDEGRID 2.0™ call, if you receive an incoming phone call and answer it, you break off from the RIDEGRID 2.0™ call.

You can keep the phone call private and you will be automatically placed back in the RIDEGRID 2.0™ call once you terminate the phone call.

**CALL MERGE**  
(MERGE/UNMERGE)

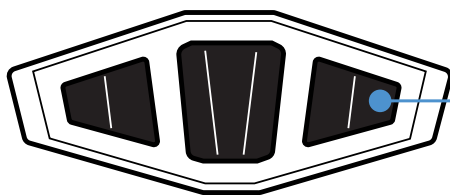

■  
PRESS TWICE  
+  
PRESS AND HOLD



07

## eRIDEGRID

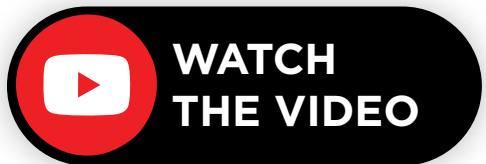

eRIDEGRID is a cloud-based extension of the RIDEGRID 2.0™ system, designed to offer a seamless ride-sharing experience without geographical limitations.

By leveraging cloud technology, eRIDEGRID enables you and your co-riders to stay connected regardless of range. eRIDEGRID allows for unlimited-distance connectivity as long as you are in network range with a data connection.

### ACTIVATING eRIDEGRID

- Create a private group in the BluArmor app.
- Before finalizing the group, ensure eRIDEGRID is enabled.
- Add members to your group.

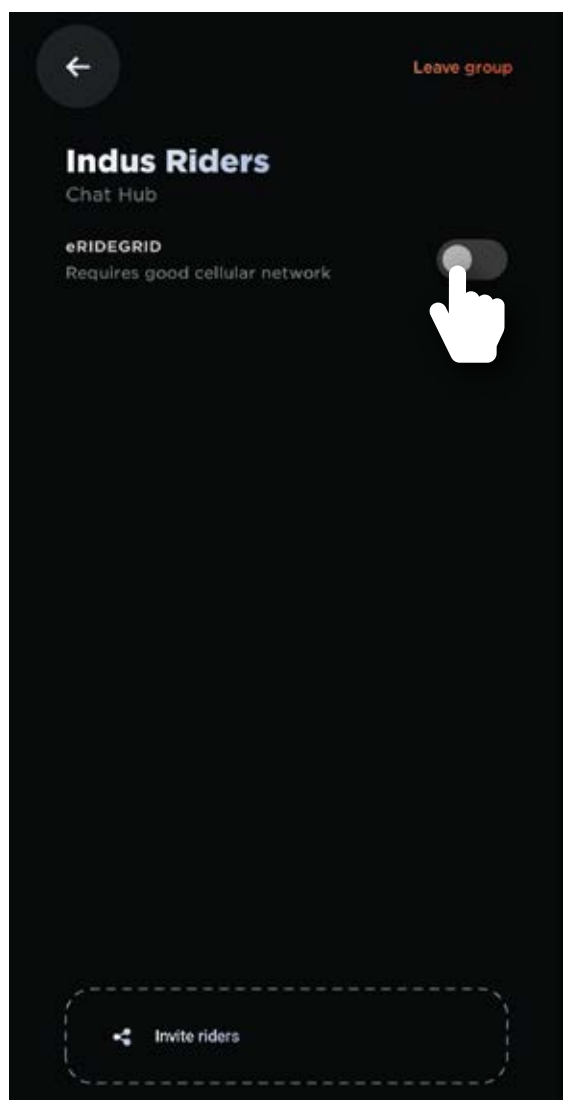

**Now, you're all set to use eRIDEGRID.**



If you and your **co-riders** are **using RIDEGRID 2.0™** with **eRIDEGRID mode** enabled, you will **seamlessly transition to eRIDEGRID mode** when **moving beyond the RIDEGRID coverage area.**

NOTE - FOR eRIDEGRID TO FUNCTION SEAMLESSLY, YOUR MOBILE NETWORK MUST REMAIN ON AT ALL TIMES



# Audio/Voice Experience

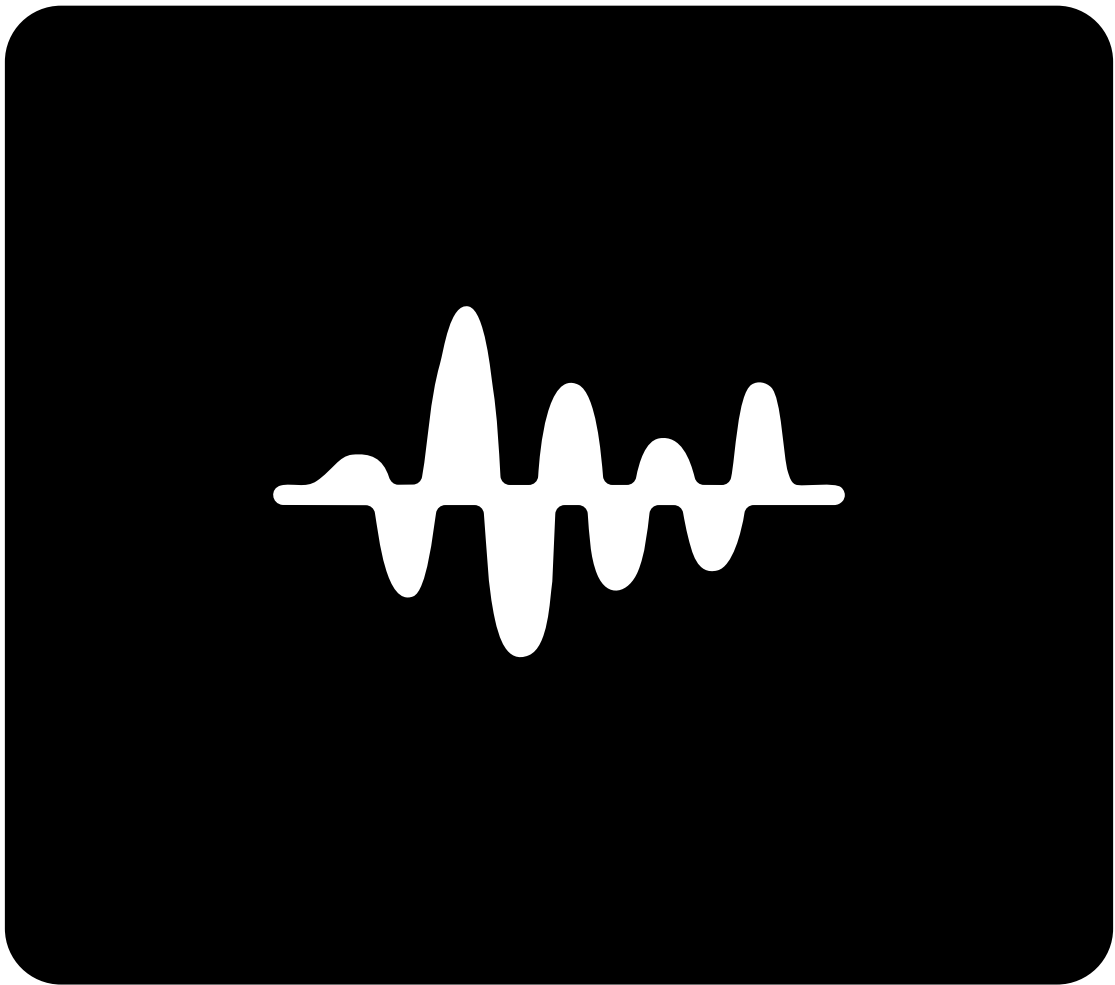
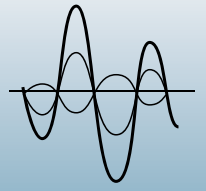

- 01** - VOLUME CONTROLS
- 02** - EQ CONTROLS FOR MUSIC
- 03** - ACTIVE NOISE CONTROL
- 04** - AUDIOWEAVE™



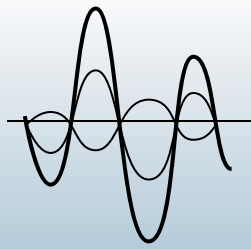

01

## VOLUME CONTROLS

**Volume control** is **possible** either **through** the **device** or **the app**. The **‘+’** and **‘-’** buttons can be **pressed once to increase** or **decrease the volume** while listening to music or attending calls.

Refer under **MUSIC VOLUME CONTROLS** section in this user manual to see how music control works using the 3 Button Module and the TStick

On the **app**, there is a **dedicated volume dial** that **allows you to set the desired volume**.

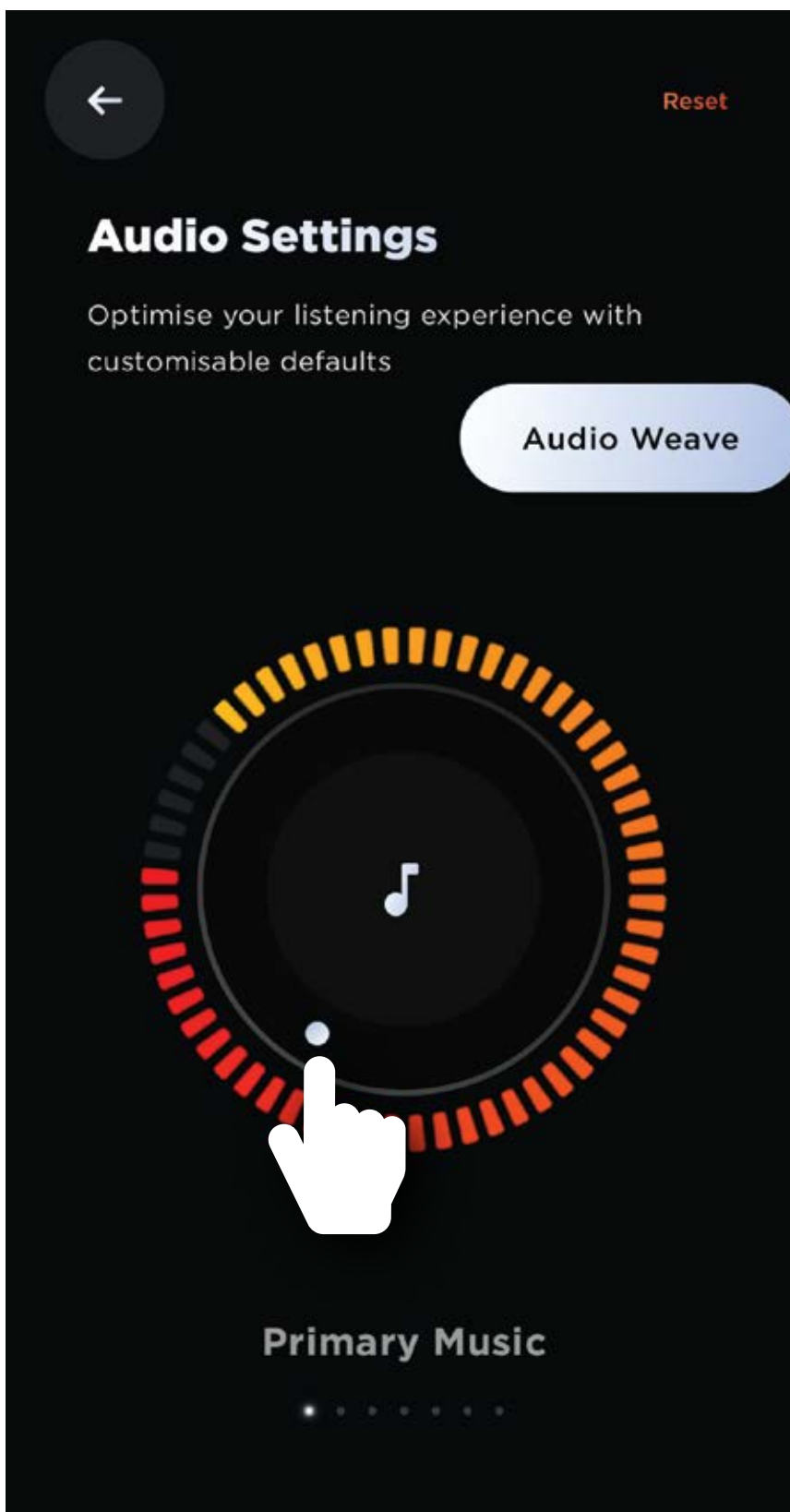

Swiping left on the dotted lines below to select and control different audio outputs (Primary voice, Music, RIDEGRID and more)

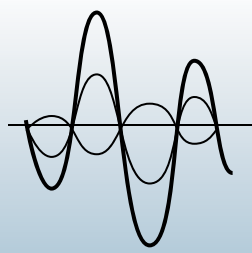

02

## EQ CONTROLS FOR MUSIC



In the menu you can access the audio presets that allow you to control Volume Boost and Equaliser Preferences.

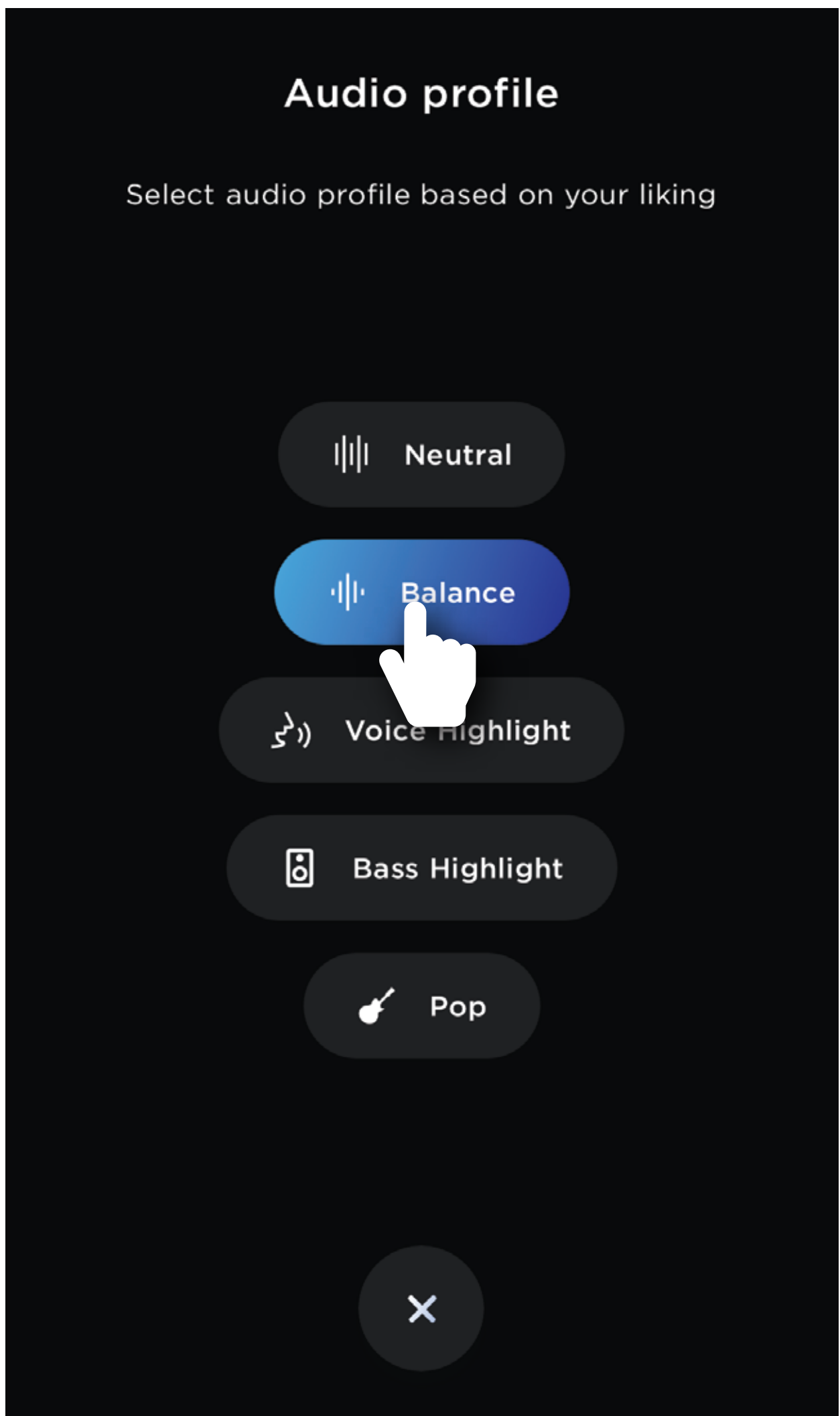

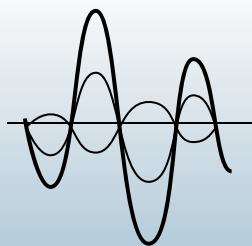

03

## ACTIVE NOISE CONTROL

Quality of voice conversations is improved through active noise control.

The algorithm suppresses wind noise in the microphone path allowing other riders to hear you clearly.

This filter is active throughout, you don't have to change any settings.

03

## AUDIOWEAVE™

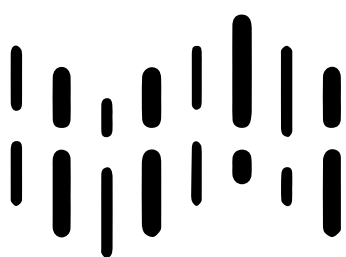

## AUDIOWEAVE™

Through AUDIOWEAVE™ technology, you can

- 1.** Continue listening to music while on a RIDEGRID 2.0™ intercom call
- 2.** Use the voice assistant while on a RIDEGRID 2.0™ intercom call
- 3.** Mix/merge audio from a RIDEGRID 2.0™ call with audio from a universal intercom call

When the user invokes the assistant, the microphone will automatically be muted for RIDEGRID 2.0™



## Audio Weave controls

An audio-overlay flag that is setup on the app will determine how the user regulates the volume between music and group intercom.

If the audio-overlay flag is OFF, then the music volume is not dependent on the activity on the RIDEGRID 2.0™ group intercom. The music will stream at a volume determined by both the phone volume and the device volume while the RIDEGRID 2.0™ intercom will operate at the device volume. If the audio-overlay flag is ON, then the music volume is dependent on the activity on the RIDEGRID 2.0™ group intercom. When there is no activity, the music will stream at a volume determined by both the phone volume and the device volume. When there is activity on the RIDEGRID 2.0™ group intercom, the music will play at 20% of the volume setting to allow the user to clearly hear the RIDEGRID 2.0™ conversations.

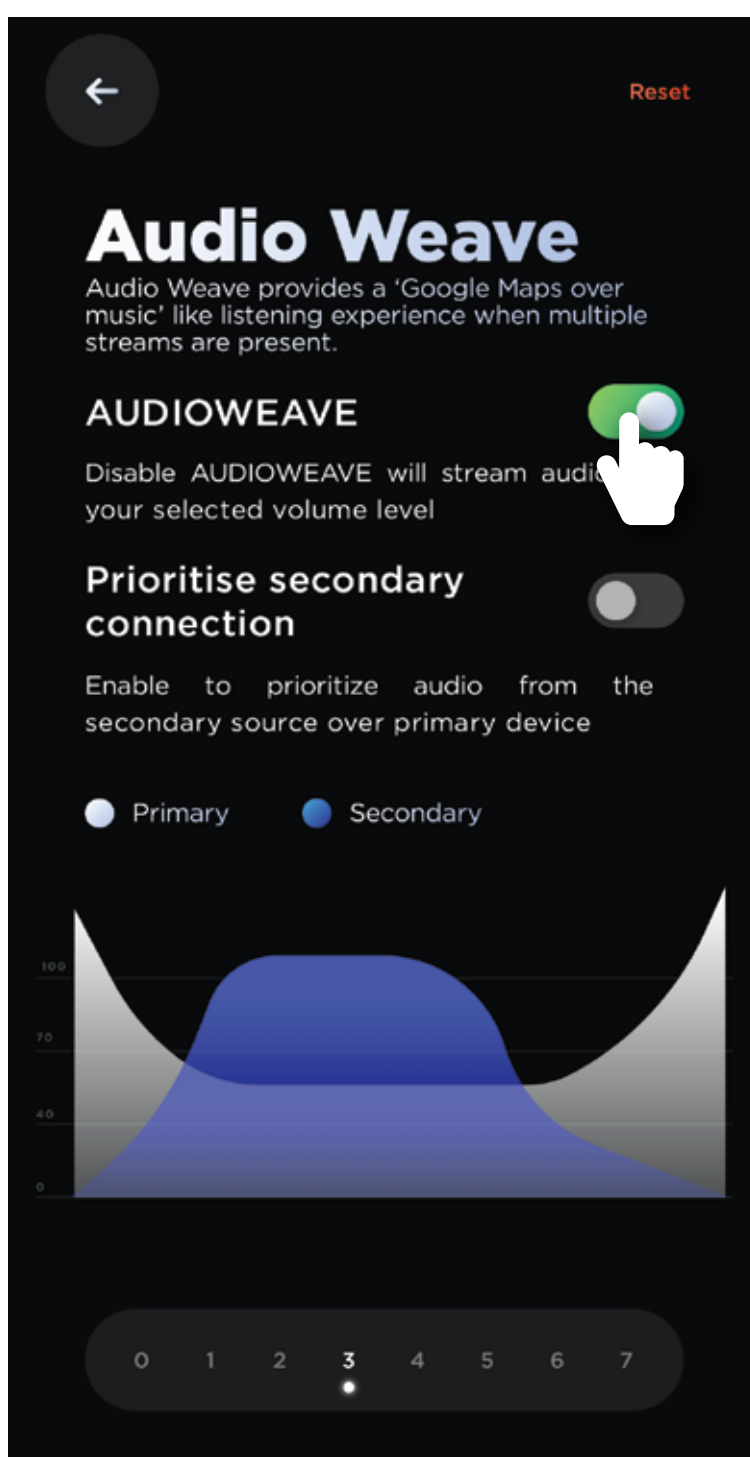



PORTWEAVE™



PORTWEAVE™

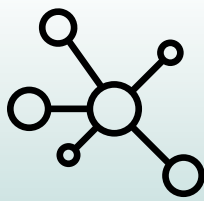

01

## WHAT IS PORTWEAVE™?

# PORTWEAVE™

MULTI POINT CONNECTIVITY

The **multipoint connectivity** feature **allows users** to **connect** one **primary device** and one **secondary device** simultaneously, such as a secondary phone, action camera, motorcycle instrument cluster, GPS navigation device, or radar detector.

NOTE - THE ABOVE-MENTIONED DEVICES MUST SUPPORT PAIRING WITH A GENERIC BLUETOOTH AUDIO DEVICE OR HEADSET.

As mentioned before, in PORTWEAVE™, You can add two connections.

### A **Primary Connection** & A **Secondary Connection**

In the **Primary Connection** you can add a **phone** or an **instrument cluster of a motorcycle**

For the **Secondary Connection**, you can use **any one** of the following, **an action cam, a radar detector, a GPS navigation device or a phone for navigation or music.**

**Follow the steps below to know how to add a primary connection and a secondary connection**

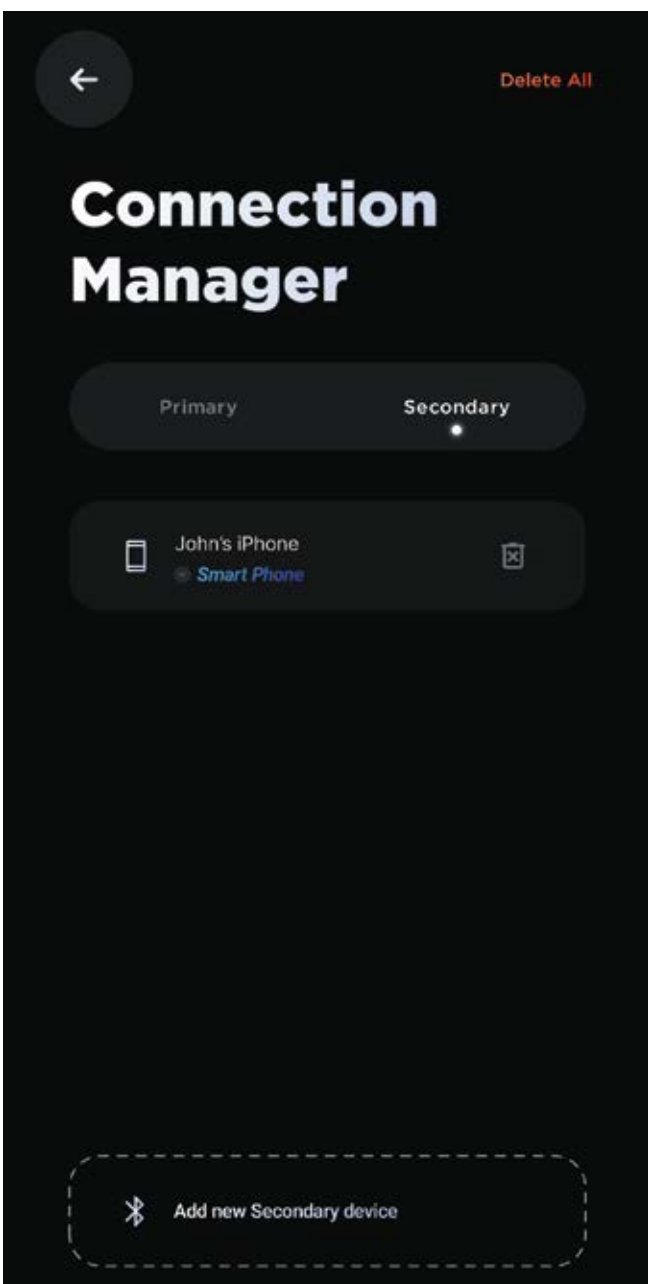
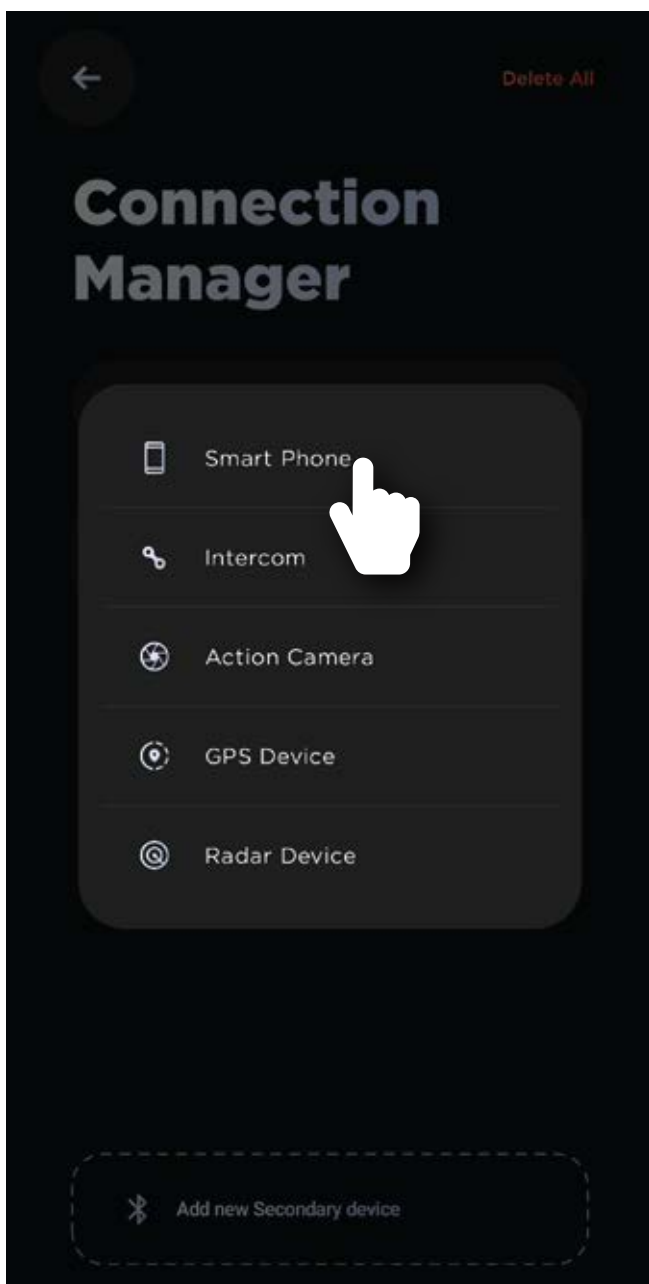
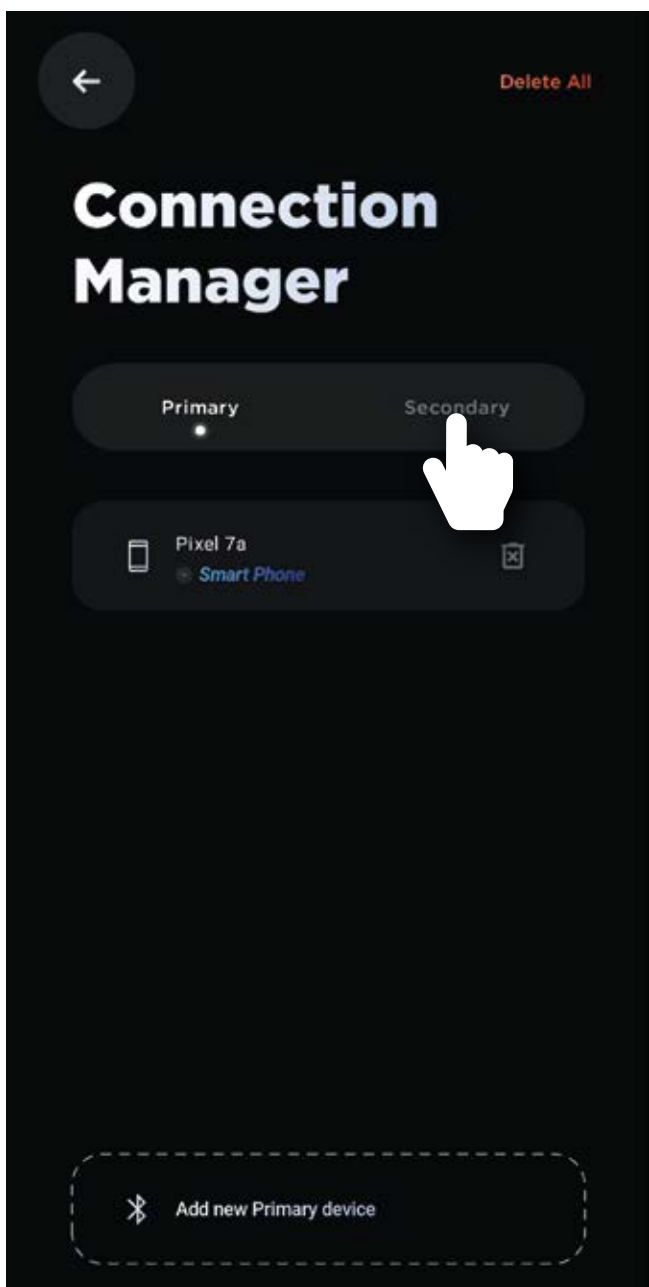



# Crash Detection

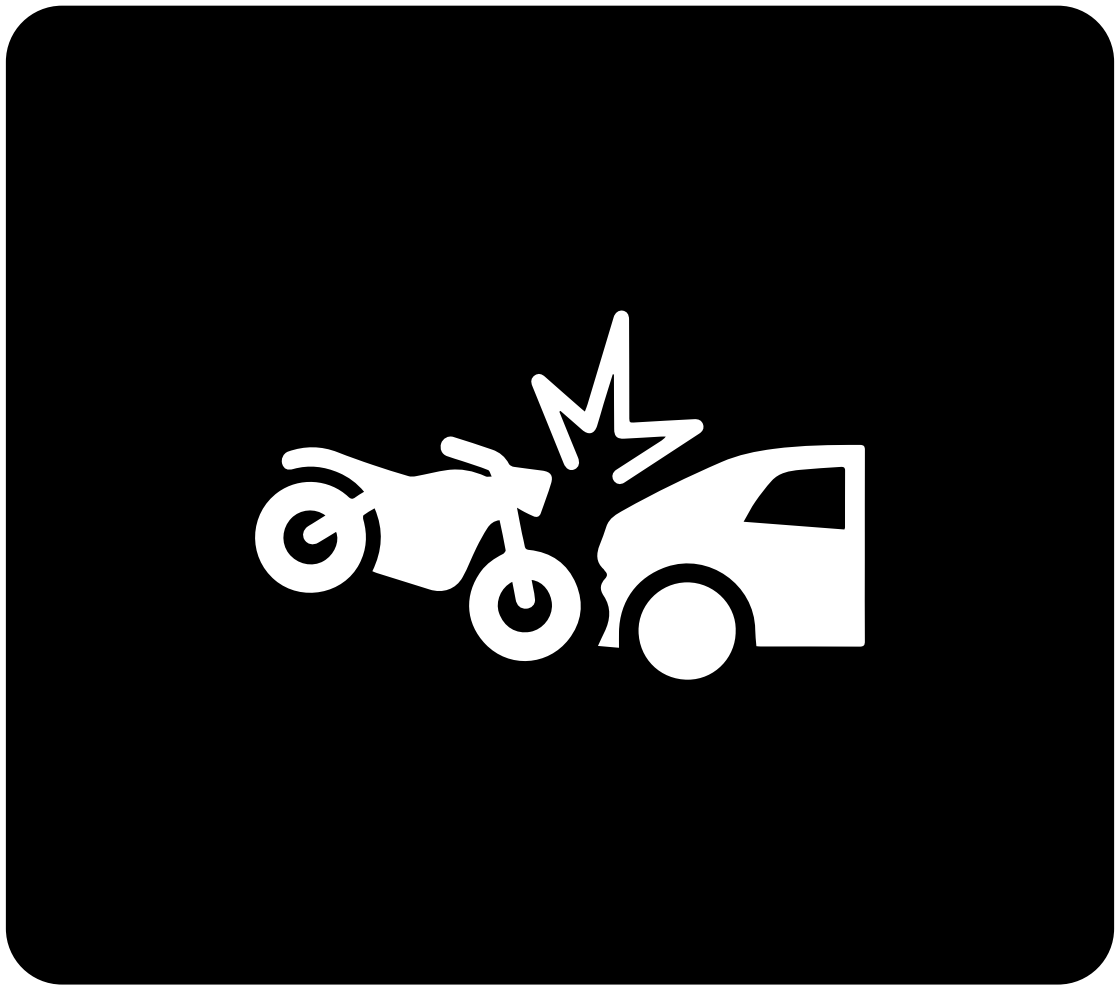
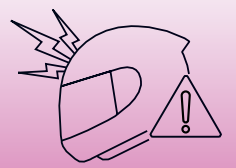

**01** - OVERVIEW

**02** - HOW TO SET UP?



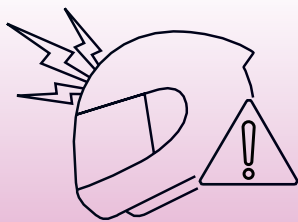

## 01 OVERVIEW

When your helmet experiences an impact during a crash, the main unit detects the force of the collision. It automatically dials your designated emergency contact, so you can inform them with relevant details about the crash, such as its location and the severity. This system ensures that help can be notified quickly.

## 02 HOW TO SET UP?



- Open the BluArmor app.
- Go to Settings.
- Select the Crash Detection tab.
- Add an emergency contact.
- Enable the 'Dial call on crash' option.

You can **customize** the **impact level** that **triggers an alert** to your **emergency contact**.

**Choose** from **Mild, Medium,** or **Severe** based on your **preference**.



# Set the emergency contact

+910909090

Select Contact

Dial call on crash



## Crash Detection Sensitivity

Choose crash detection sensitivity levels to match your activity or environment

Mild

Medium

Severe



Update

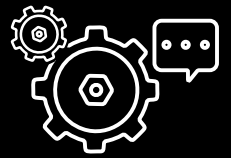

## FACTORY RESET

FACTORY RESET THE MAIN UNIT

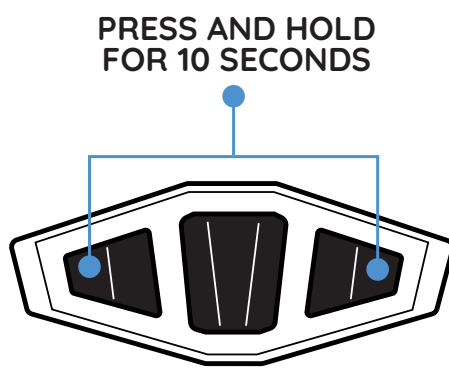

## REBOOT

REBOOT THE MAIN UNIT

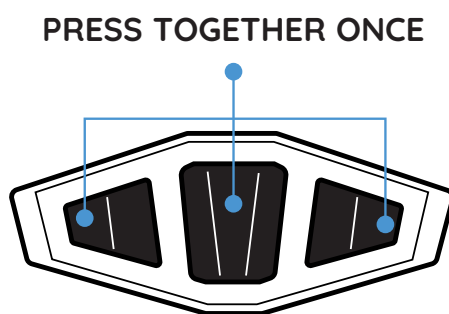

RIDE . CONNECT . BOND